

TechnoAide

Imaging

Medicine

Radiology

MRI

CT

Mammography

Interventional

Ultrasound

Cardiology

2014

A			
Apparel, Lead Protective.....	2-25		
Belt.....	15		
Breast.....	10		
Fabric Selection.....	25		
Front Protection.....	4-6		
Full Wrap-Around.....	8		
Glasses.....	16-19		
Gloves.....	14		
Gonadal.....	12		
Half.....	10-11		
Hat.....	14		
Pediatric.....	12-13		
Pregnancy.....	10		
Racks.....	20-21		
Skirt/Kilt.....	7		
Tote Bag.....	15		
Thyroid Collars.....	9		
Vests.....	6-7		
Aprons.....	2-25		
Apron / Glove Racks.....	20-21		
B			
Badge Boards.....	45		
Bariatric:			
Gowns.....	77		
Sandbags & Sponges.....	64, 70-71		
Step Stool.....	46		
Transfer Board.....	72		
Wheelchairs.....	32-35, 55		
Belt Guard.....	15		
Blanket, lead.....	15		
Blockers, lead.....	31		
Bolsters.....	68		
Book.....	45		
Boxes, storage.....	103		
C			
Cabinets.....	101-103		
Caddies.....	100		
Caliper.....	75		
Capes, disposable.....	77		
Carts.....	104-105		
Cassette/DR/CR:			
Blockers.....	31		
Covers.....	43		
Holders.....	31, 38-42		
Category Inserts.....	98		
CD Mailers and Sleeves.....	99		
Chairs.....	36-37, 116-120		
Chart Holder.....	44		
Chest Support.....	75		
Cleaners.....	76		
Colors: Apparel.....	25		
Cabinet.....	102		
Furniture.....	111		
Upholstery.....	120		
Copier, x-ray film.....	92		
Covers:			
Cassette/DR-CR-Plate.....	43		
CPU Holder.....	114		
CR Carts & Bins.....	31, 104-105		
CR Plate Holder:			
Table Top.....	4141		
Mobile.....	38-41		
D			
Desk Accessories.....	114-115		
Desks.....	108-111		
Digital Imaging:			
Chairs (all ergonomic seating).....	116-120		
Support Carts.....	103		
Workstations.....	106-107		
Disinfectant.....	76		
Disposable capes, gown, bedding.....	77		
DR Plate Holder.....	38-42		
Drapes.....	29-30		
Duplicator, x-ray film.....	92		
E			
Ear Plugs.....	56		
Ergonomic Chairs.....	116-119		
Ergonomic Furniture.....	108-120		
Ergonomic Workstations.....	106-111		
Exam Lamps.....	48		
Extremity Rulers.....	83		
F			
Fabric Selections.....	25-120		
Face Shield.....	19		
File Jackets, X-Ray.....	96-98		
Film Caddies.....	100		
Furniture:			
Accessories.....	112-115		
Chairs.....	116-120		
Desks.....	108-111		
G			
Gel Warmers.....	53		
Germicide.....	15, 76		
Glasses, lead protective.....	16-19		
Gloves, lead.....	14		
Gonadal Shields.....	12		
Gowns, disposable.....	77		
Gurney.....	36-37, 55		
H			
Half Aprons.....	10-11		
Hamper.....	47		
Hats & Hoods.....	14		
Head Paddles/Immobilizer.....	75		
I			
I.D. Printer & Cards.....	93		
Illuminators.....	94-95		
Image Receptor Covers.....	43		
Image Receptor Holder.....	38-42		
Immobilizers.....	73		
Instrument Stand.....	47		
IV Poles.....	47		
K			
Keyboard Support.....	114		
L			
Labels.....	97		
Lamps.....	48		
Lateral Cassette Holders.....	38-42		
Lateral Chest Support.....	75		
Lead Barriers, Mobile.....	26-28		
Lead Blockers.....	31		
Lead Glasses.....	16-19		
Lead Protective Apparel.....	2-25		
Lead Shield.....	26-28		
Leg Support.....	75		
Lint-Free Wipes.....	76		
Lifting Straps.....	72		
M			
Mailers.....	99		
Mammography:			
biopsy chair.....	36		
capes.....	77		
disinfectant.....	76		
half apron.....	10-11		
jacket.....	97		
markers.....	88-89		
organizers/caddies.....	100		
thyroid collar.....	9		
Markers.....	78-91		
Clippers.....	84		
Copper.....	84		
Digital.....	83		
Extremity Rulers.....	83		
Fun.....	80-82		
Glitter.....	81		
Letters & Holders.....	90-91		
Multi-Modality.....	89		
Nipple.....	88-89		
Oncology.....	84, 86		
Personalized.....	78-82		
Position Indicator.....	78-79		
Skin.....	88-89		
Stickers.....	87		
Thin.....	83-84, 86		
Words, singles and sets.....	86		
Marking Pens.....	87		
Merrill's Pocket Guide (Reference).....	45		
Mobile Apron Stands.....	20		
Mobile Barriers.....	26-28		
Mobile Imaging Caddy.....	44		
Mobile IR Holders.....	38-41		
Mobile Workstations.....	106-107		
Mobile Sandbag Rack.....	71		
Monitor Supports.....	112-113		
Motorized Chair.....	36-37		
MRI:			
Ear Plugs.....	56		
IV Pole.....	54		
Metal Detector.....	56		
Sandbags.....	57		
Seated Stool.....	54		
Signs.....	56		
Sponges.....	56, 69		
Step Stools.....	54		
Stretchers.....	55		
Tab Pads.....	69		
Transfer Board.....	57		
Wheel Chairs.....	55		
N			
Negative Preservers.....	98		
P			
Pads, Table.....	69, 74		
Pillow Cases, disposable.....	77		
Portable Lead Shield.....	28		
Pregnancy Apron.....	10		
Probe Covers.....	52		
R			
Rack: Apron / Glove.....	19-20		
Cassette.....	38-41		
Chart Holder.....	44		
CR.....	31		
Film Holder.....	44		
Table Pad.....	74		
Transfer Board.....	72		
Restraints.....	72-73		
S			
Safelights.....	92		
Sandbags.....	57, 70-71		
Scatter Shields.....	26-30		
Sheets and Table Paper.....	77		
Shields.....	26-28		
Signs: Custom.....	51		
General.....	50-51		
Illuminated.....	92		
MRI.....	51		
Skin Markers.....	88-89		
Sponges:			
Bariatric.....	64		
Bolster.....	68		
General.....	58-64		
Kits (sets).....	65-68		
MRI.....	56, 69		
Ultrasound.....	59, 64, 67		
Stand, Mayo.....	547		
Step Stools.....	46, 54		
Stools: Bariatric.....	46		
MRI.....	54		
Seated.....	49, 53, 119		
Step.....	46, 54		
Storage Boxes.....	103		
Storage Cabinets.....	101-103		
Stretcher.....	36-37, 55		
T			
Table Drapes.....	29		
Table Pad & Rack.....	74		
Thyroid Collar.....	9		
Transfer Boards.....	72		
U			
UltraSound:			
Disinfectant.....	76		
Gels.....	52		
Probe Covers.....	52		
Sponge.....	59, 64, 67		
Stools.....	53		
Warmers.....	53		
Utility Cart.....	104		
V			
Vest, x-ray protective.....	6-7		
Video Imaging Chair.....	37		
View Boxes.....	94-95		
View Spot.....	95		
W			
Wall Mount Workstations.....	106-107		
Weight Bearing Stand.....	42		
Wheelchairs.....	32-35, 55		
Wipes.....	76		
Workstations.....	106-111		
X			
X-Ray Jackets.....	96-98		

protective apparel 2-25

shielding / barriers 26-31

transportation 32-37

general accessories 38-51

ultrasound / mri 52-57

patient handling 58-77

markers 78-91

darkroom / viewing 92-95

filing systems 96-103

imaging support 104-107

fusion ergo 108-120

index on page 121

We've been busy. In order to bring you the *best protective apparel available* we *revamped our patterns and sizing charts* and added a number of new products and enhancements from aprons, vest, and skirts to pediatric protection and an all *new Cooling Panel* to make your job easier and more comfortable. Turn the pages to find out more!



Meet Heather Figlioli, Pattern Specialist from O'More College of Design.



**New Patterns!
New Sizing!
Better Fit!**

Free Stuff on applicable garments:

Shoulder Pads

Double Pocket

Double-Fold Binding

Embroidery

Recycling

MEDIA

Regular Lead

Lightweight Lead

"LMG"*

BENEFITS

Most Economical and Recyclable

Lighter than Regular Lead and Recyclable

Lightest Weight, Lead-Free, Environmentally Friendly

PROTECTION

100% Lead

Lead-Tin

Tungsten-Antimony

ATTENUATION

0.5mm Pb Equiv. Protection averages 97% Attenuation over 80,100,120 KVP

0.5mm Pb Equiv. Protection averages 96.8% Attenuation over 80,100,120 KVP

0.5mm Pb Equiv. Protection averages 96.6% Attenuation over 80,100,120 KVP

WEIGHT

9-lbs (based on medium front protection apron)

8-lbs (based on medium front protection apron)

7-lbs (based on medium front protection apron)

*Media is IEC/EN 61331-1 / ASTM Approved.

A Techno-Aide
Exclusive:

CTAV™ cooling Technology for Aprons & Vests

Keep your cool with the
CTAV™ Cooling Panel!

Lightweight • Practical • Effective

Patent Pending passive
cooling system uses:

- no circulating water
- no dangling tubes
- no ice packs
- no hazardous chemicals

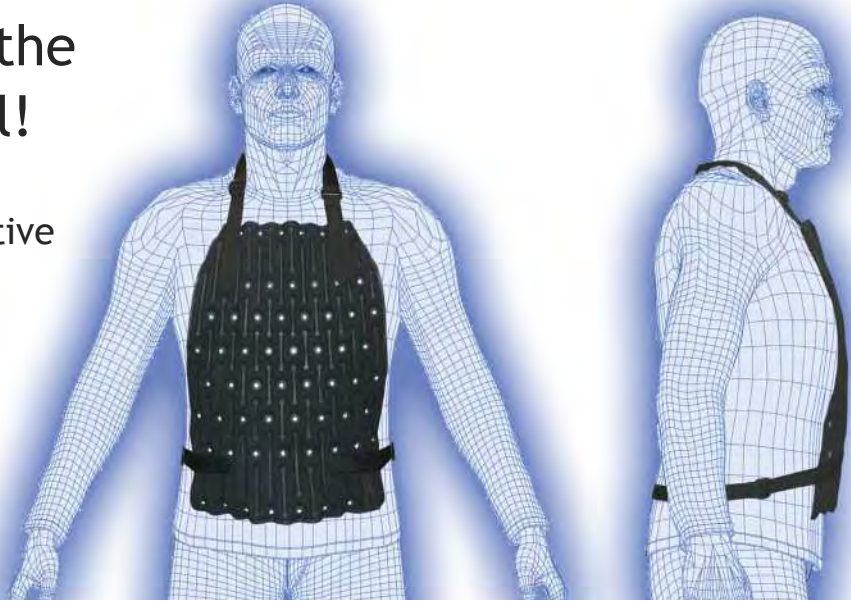

Featuring **EVERDRY™**

Antimicrobial, antifungal nanocrystal
surface keeps you dry and comfortable.

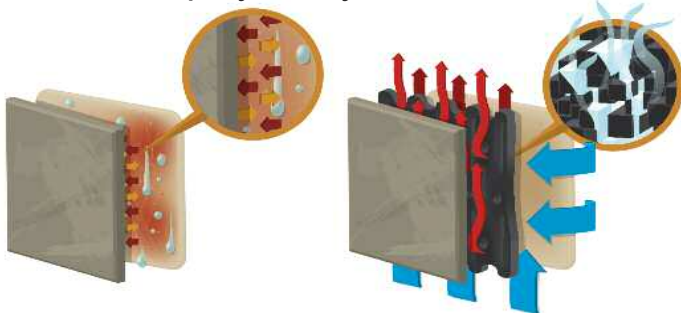

Without **CTAV™**:

- Heat and moisture are trapped between the skin and apparel.
- Sweat cannot evaporate.
- Increased fatigue.
- Heat stress and loss of alertness, concentration, and focus.

With **CTAV™**:

- Air flows across the torso and CTAV™ panel.
- Body heat escapes through passive convection.
- Metabolic heat is conducted into inflated chambers and naturally vents from behind apparel.

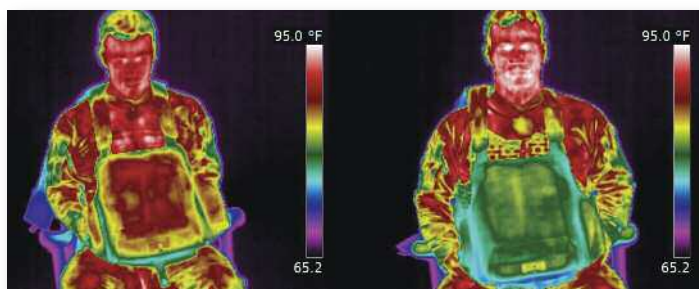

Up to 16.2% or 9° reduction in body heat!

The story:

CTAV™ technology was originally designed to keep police and military personnel cool under pressure while wearing a shielded vest or flack jacket.

Now, Techno-Aide is proud to bring this technology to you, to keep you cool when wearing radiation protection garments for extended or multiple exams.

Features and benefits of **CTAV™**:

- Heat is no longer trapped between you and your apron or vest.
- Passive cooling convective airflow allows your body heat to escape.
- Increased natural ventilation of metabolic body heat.
- Does not affect range of motion.
- Ribbed, air-filled panel dissipates heat and heat storage from the body and the apron or vest.
- Quick harness is repositionable to make the perfect fit for you.
- Quick-action hand air pump is included.

CTAV™ Cooling Panels

cat.#	actual panel size	price
CTAV-C1012	10" x 12"	\$149.00
CTAV-C1114	11" x 14"	\$149.00
CTAV-C1116	11" x 16"	\$149.00



Most Popular Apron!



Buckle

EZ•Guard

All Purpose Front Protection Apron

- EZ-On / EZ-Off.
- Available with hook & loop or 2" buckle closure.
- 0.5mm Pb equivalency protection (0.375mm available).
- Free dual pocket and shoulder pads.

EZ•GUARD with Hook & Loop Closure

cat.#	lead type	petite small medium	large x-large	2X 3X
EVR	Regular	\$205.00	\$220.00	\$245.00
EVL	Light Wt.	\$260.00	\$285.00	\$310.00
EVG	LMG Lead-Free	\$310.00	\$330.00	\$360.00

EZ•GUARD with Buckle Closure

cat.#	lead type	petite small medium	large x-large	2X 3X
EBR	Regular	\$205.00	\$220.00	\$245.00
EBL	Light Wt.	\$260.00	\$285.00	\$310.00
EBG	LMG Lead-Free	\$310.00	\$330.00	\$360.00



Buckle

Flex•Guard

Flexible-Back Apron

- Stretch back provides greater comfort by placing more weight on the hips and less weight on the shoulders.
- Available with hook & loop or 2" buckle closure.
- 0.5mm Pb equivalency protection (0.375mm available).
- Free dual pocket and shoulder pads.

*See Best-Fit
Sizing Chart
on page 22.*

FLEX•GUARD with Hook & Loop Closure

cat.#	lead type	petite small medium	large x-large	2X 3X
FVR	Regular	\$215.00	\$230.00	\$255.00
FVL	Light Wt.	\$275.00	\$295.00	\$325.00
FVG	LMG Lead-Free	\$325.00	\$340.00	\$365.00

FLEX•GUARD with Buckle Closure

cat.#	lead type	petite small medium	large x-large	2X 3X
FBR	Regular	\$215.00	\$230.00	\$255.00
FBL	Light Wt.	\$275.00	\$295.00	\$325.00
FBG	LMG Lead-Free	\$325.00	\$340.00	\$365.00

- **COLORS & FABRICS:** page 25.
- **Default Fabric:** Royal Blue nylon.
- **2-Year Limited Warranty.**

Surgery•Guard / Surgical Drop-Off Apron



Easily Slides Off under Sterile Gown

- No compromise of sterile field.
- Crossover shoulder-to-hip hook & loop closure.
- 0.5mm Pb equiv. front protection.
- Free dual pocket and shoulder pads.

cat.#	lead type	petite small medium	large x-large	2X 3X
SRR	Regular	\$205.00	\$225.00	\$255.00
SRL	Light Wt.	\$250.00	\$275.00	\$300.00
SRG	LMG Lead-Free	\$305.00	\$325.00	\$350.00

OR•Guard / Shoulder Drop-Off Apron



Slides Off under Sterile Gown

- No compromise of sterile field.
- Flexible back, like the Flex-Guard.
- Break-away shoulders and hips.
- 0.5mm Pb equiv. front protection.
- Free dual pocket and shoulder pads.

cat.#	lead type	petite small medium	large x-large	2X 3X
ORR	Regular	\$245.00	\$260.00	\$285.00
ORL	Light Wt.	\$295.00	\$320.00	\$345.00
ORG	LMG Lead-Free	\$330.00	\$350.00	\$375.00

Ortho•Guard / Apron with attached Belt•Guard



Built-in Back-Guard for Maximum Support

- Tethered belt can be adjusted vertically and laterally for effective back support.
- Back strap assures best fit and comfort.
- 0.5mm Pb equiv. front protection.
- Free dual pocket and shoulder pads.

Shoulder
Strap
Included!

cat.#	lead type	petite small medium	large x-large	2X 3X
OGR	Regular	\$245.00	\$260.00	\$285.00
OGL	Light Wt.	\$295.00	\$320.00	\$345.00
OGG	LMG Lead-Free	\$330.00	\$350.00	\$375.00

Econo•Guard Economy Apron

Excellent Protection, Value Priced

- 1" buckle closure (long enough to tie).
- 0.5mm Pb equivalency front protection.
- Available in any fabric.
- See Best-Fit size chart on page 22.

ECONO•GUARD

cat.#	lead type	petite small medium	large x-large	2X 3X
EGR	Regular	\$135.00	\$155.00	\$180.00
EGL	Light Wt.	\$215.00	\$235.00	\$265.00
EGG	LMG Lead-Free	\$280.00	\$295.00	\$325.00

Not compatible with attached thyroid collarar.



- **COLORS & FABRICS:** page 25.
- Default Fabric: **Royal Blue nylon.**
- 2-Year Limited Warranty.



Vest•Wrap

Less Bulk, Better Fit for Freedom of Movement

- Separate Men and Women's styles for best comfort.
- Distributes weight between shoulders and hips.
- 0.5mm Pb equivalency protection front, 0.25mm back.
- Hook & loop closure with *flexible back*.
- Generous armholes for EZ-fit.
- Free dual pocket and shoulder pads.

VEST•WRAP Female

cat.#	lead type	petite small medium	large x-large	2X 3X
VGR	Regular	\$185.00	\$200.00	\$225.00
VGL	Light Wt.	\$250.00	\$275.00	\$300.00
VGG	LMG Lead-Free	\$290.00	\$310.00	\$335.00

See Skirts and
Kilts on p.7.

VEST•WRAP Male

cat.#	lead type	petite small medium	large x-large	2X 3X
VBR	Regular	\$190.00	\$205.00	\$230.00
VBL	Light Wt.	\$260.00	\$280.00	\$310.00
VBG	LMG Lead-Free	\$310.00	\$330.00	\$360.00

- **COLORS & FABRICS:** page 25.
- Default Fabric: **Royal Blue nylon.**
- 2-Year Limited Warranty.



Female Vest



Male Vest

**Newly Tailored
to assure the most
Comfortable Fit!**

Vest•Guard

New Design: Saves Weight, Better Fit

- Separate Men and Women's styles for best comfort.
- Full front overlap design saves weight.
- Distributes weight between shoulders and hips.
- 0.5mm Pb equivalency protection front, 0.25mm back.
- Hook & loop closure is fast and easy.
- Free dual pocket and shoulder pads.

VEST•GUARD Female

cat.#	lead type	petite small medium	large x-large	2X 3X
VFR	Regular	\$185.00	\$200.00	\$225.00
VFL	Light Wt.	\$250.00	\$275.00	\$300.00
VFG	LMG Lead-Free	\$290.00	\$310.00	\$335.00

VEST•GUARD Male

cat.#	lead type	petite small medium	large x-large	2X 3X
VMR	Regular	\$190.00	\$205.00	\$230.00
VML	Light Wt.	\$260.00	\$280.00	\$310.00
VMG	LMG Lead-Free	\$310.00	\$330.00	\$360.00

(Vests do not include the two 1" safety buckles as shown. If you would like these as a *FREE Add-On*, please specify at the time of ordering.)

**See Best-Fit
Sizing Chart
on page 22.**



Female Kilt



Male Kilt

Skirt/Kilt•Guard

All Day Comfort for the Lower Body

- Separate Men and Women's styles for best comfort.
- Weight is distributed evenly around hips.
- Wrap around protection: .5mm Pb Eq front, .25mm back.
- Hook & loop closure with 2" safety buckle.
- Free pocket and waist pad.

SKIRT•GUARD Female

cat.#	lead type	petite small medium	large x-large	2X 3X
SFR	Regular	\$185.00	\$200.00	\$225.00
SFL	Light Wt.	\$250.00	\$275.00	\$300.00
SFG	LMG Lead-Free	\$290.00	\$310.00	\$335.00

KILT•GUARD Male

cat.#	lead type	petite small medium	large x-large	2X 3X
KMR	Regular	\$190.00	\$205.00	\$230.00
KML	Light Wt.	\$260.00	\$280.00	\$310.00
KMG	LMG Lead-Free	\$310.00	\$330.00	\$360.00

Max•Wrap

Wrap around, full-body protection coat-style garment

- Distributes weight between shoulders and hips.
- 0.5mm Pb equivalency protection front, 0.25mm back.
- Hook & loop closure with *flexible back* is fast and easy.
- Generous armholes for EZ-fit.
- Free dual pocket and shoulder pads.

Innovative Max Design!

Solid front and back panels provide:

- no overlap means less bulk, better fit
- better freedom of movement
- secure closure at waist and shoulder
- flexible back support panels
- lighter weight

cat.#	lead type	petite small medium	large x-large	2X 3X
MWR	Regular	\$295.00	\$310.00	\$335.00
MWL	Light Wt.	\$395.00	\$415.00	\$440.00
MWG	LMG Lead-Free	\$425.00	\$445.00	\$470.00

Max•Guard Plus

Overlap wrap around offers full-body protection

- Distributes weight between shoulders and hips.
- 0.5mm Pb equivalency protection front, 0.25mm back.
- Hook & loop closure with inside elastic Back-Guard.
- Front belt assures snug fit and maximum support.
- Generous armholes for EZ-fit.
- Free dual pocket and shoulder pads.

Inside:
built-in
6" elastic
back support.

[See Best-Fit
Sizing Chart
on page 22.](#)

cat.#	lead type	petite small medium	large x-large	2X 3X
MXR	Regular	\$295.00	\$310.00	\$335.00
MXL	Light Wt.	\$395.00	\$415.00	\$440.00
MXG	LMG Lead-Free	\$425.00	\$445.00	\$470.00

- **COLORS & FABRICS:** page 25.
- **Default Fabric:** Royal Blue nylon.
- **2-Year Limited Warranty.**

Thyro•Guards

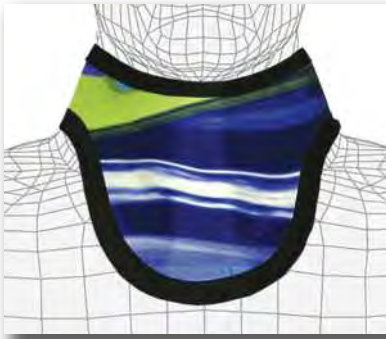

STANDARD

cat.#	lead type	price
TYR	Regular	\$49.00
TYL	Light Wt.	\$58.00
TYG	LMG Lead-Free	\$70.00

Binding all around means affordable comfort and flexibility.



NO BINDING

cat.#	lead type	price
TNR	Regular	\$64.00
TNL	Light Wt.	\$72.00
TNG	LMG Lead-Free	\$84.00

No binding means extra comfort, flexibility and lighter weight.



MID-BINDING

cat.#	lead type	price
TVR	Regular	\$57.00
TVL	Light Wt.	\$65.00
TVG	LMG Lead-Free	\$77.00

No binding at the top means extra comfort under the chin.

ATTACHED STANDARD

cat.#	lead type	price
TAR	Regular	\$61.00
TAL	Light Wt.	\$69.00
TAG	LMG Lead-Free	\$82.00

ATTACHED NO BINDING

cat.#	lead type	price
TCR	Regular	\$77.00
TCL	Light Wt.	\$83.00
TCG	LMG Lead-Free	\$94.00

ATTACHED MID-BINDING

cat.#	lead type	price
TWR	Regular	\$69.00
TWL	Light Wt.	\$77.00
TWG	LMG Lead-Free	\$88.00



Unique 2-in-1 pockets in one

All Attached Thyroid Collars include:

- Snap ring for easy collar attachment.
- Attach anytime with tethered strap.
- Unique 2-in-1 pocket design: store collar in one pocket and use the other pocket for accessories.

COLLAR COVER: DISPOSABLE



#TCC
\$125.00/box

- Keep multi-person collars sanitary.
- Helps prevent cross-contamination.
- 100 tissue-poly covers per box.

COLLAR COVER: WASHABLE



#TCW
\$38.00

- Fabric cover offers best comfort.
- Fits regular or attached collars.
- Seamed top, hook & loop bottom.
- Royal Blue or you choose color (p25).



(Berry with Pink ribbon only)

MAMMOGRAPHY

cat.#	lead type	price
TMR	Regular	\$61.00
TML	Light Wt.	\$69.00
TMG	LMG Lead-Free	\$80.00

Shorty patient collar offers protection without compromising breast imaging.



PEDIATRIC

cat.#	lead type	price
TPR	Regular	\$44.00
TPL	Light Wt.	\$52.00
TPG	LMG Lead-Free	\$65.00

Small patient collar offers protection during pediatric imaging.

- Standard, No-Binding, and Mid-Binding collars are 6" tall x 6 1/2" wide x 24" strap.
- Select **COLOR** and **FABRIC** on page 25.
- Default color is **Royal Blue** except for Mammo Collar (Berry only).

Care•Guard Pregnancy Apron

Attached
Thyroid Collar
Available



Front Apron

Back Apron

Front & Back

Special Protection for Fetal Care FRONT Details:

- Front protection with flexible back straps.
- 1.0mm Pb equivalency over fetal area, 0.5mm over remaining area.
- 22" x 24" pregnancy panel can be removed at completion of pregnancy to create a standard Flex•Guard Apron with 0.5mm Pb equivalency protection.
- Hook & loop closure is fast and easy.
- Free dual pocket and shoulder pads.

BACK Details:

- Complements the Front Apron for full protection.
- 0.25mm Pb equivalency.
- 1" buckle closure (long enough to tie) in front.

CARE•GUARD Front ONLY

cat.#	lead type	regular	tall/full
CGR	Regular	\$310.00	\$335.00
CGL	Light Wt.	\$445.00	\$465.00
CGG	LMG Lead-Free	\$495.00	\$515.00

CARE•GUARD Back ONLY

cat.#	lead type	regular	tall/full
CBR	Regular	\$ 95.00	\$115.00
CBL	Light Wt.	\$160.00	\$175.00
CBG	LMG Lead-Free	\$195.00	\$225.00

size	(width x length)
Regular	(24" x 36")
Tall	(24" x 40")
Full	(28" x 38")

Choose your own colors from Page 25. Two colors shown here are to depict separate aprons.

Breast•Guard Female Breast Protection

- Allows full viewing of anatomy EXCEPT sensitive breast tissue.
- Hook and Loop strap drapes around the neck.
- Adjust shields anywhere along the strap.
- 0.5mm Pb equiv. protection.
- Two convenient sizes:
Adult: 6" wide x 7" high;
Child: 4" wide x 4½" high.



Set = two shields + one strap

cat.#	lead type	price/set
BSR	Regular	\$58.00
BSL	Light Wt.	\$66.00
BSG	LMG Lead-Free	\$73.00

size	(description)
A	(Adult)
C	(Child)

Pregnancy Lap•Guard Half Apronette

- Standard Lap•Guard, but with 1.0mm Pb equivalency protection.
- Excellent protection for pregnant patients requiring x-ray.

1.0mm Pb Equivalency for Pregnant Patients

cat.#	lead type	medium	large	x-large	2X
LPR	Regular	\$88.00	\$96.00	\$106.00	\$131.00
LPL	Light Wt.	\$116.00	\$130.00	\$140.00	\$147.00
LPG	LMG Lead-Free	\$172.00	\$199.00	\$214.00	\$236.00



- Select COLOR and FABRIC type from page 25.
- Default color and fabric are Royal Blue nylon.
- 2-Year Warranty on materials and workmanship.
- Oversize Garments and Custom Sizing Patterns available.

Semi•Guard

Extra Coverage Half Apronette

- Convenient hook & loop closure.
- 0.5mm Pb equivalency protection.
- Excellent protection for patient and staff.



Individual default apronette color is Royal Blue, unless specified.

size	(width x length)
S	(12" x 12")
M	(18" x 16")
L	(24" x 20")
X	(24" x 24")
2X	(36" x 24")
Half	(24" x 12")
Kids*	(8" x 10")

*See Kids Lap-Guard p.13

Lap•Guard

Buckle Closure Half Apronette

- Easy-to-use 1" buckle belt closure.
- 0.5mm Pb equivalency protection.
- Excellent protection for patient and staff.



SEMI•GUARD

cat.#	lead type	small	med/half	large	x-large	2X
SGR	Regular	\$56.00	\$68.00	\$79.00	\$90.00	\$119.00
SGL	Light Wt.	\$69.00	\$98.00	\$117.00	\$129.00	\$194.00
SGG	LMG Lead-Free	\$99.00	\$155.00	\$181.00	\$204.00	\$307.00

LAP•GUARD

cat.#	lead type	small	med/half	large	x-large	2X
LGR	Regular	\$52.00	\$62.00	\$70.00	\$79.00	\$135.00
LGL	Light Wt.	\$62.00	\$90.00	\$104.00	\$114.00	\$172.00
LGG	LMG Lead-Free	\$93.00	\$145.00	\$173.00	\$187.00	\$282.00

SEMI•GUARD SET

cat.#	lead type	price
STR	Regular	\$330.00
STL	Light Wt.	\$440.00
STG	LMG Lead-Free	\$655.00



Semi•Guard & Lap•Guard SETS include a 2-Peg Pack and the following apronettes:

- small (*yellow*)
- medium (*berry*)
- large (*royal blue*)
- extra-large (*green*)

LAP•GUARD SET

cat.#	lead type	price
LTR	Regular	\$300.00
LTL	Light Wt.	\$400.00
LTG	LMG Lead-Free	\$620.00

Demi•Guard

Half Apron

- Child to Adult loin protection.
- 0.5mm Pb equivalency front protection.
- Available with 1" buckle closure or convenient Waist Ring.



DEMI•RACK (only)
Cat.# DDD \$ 215.00

DEMI•GUARD with WAIST RINGS

cat.#	lead type	small	medium	large	x-large
DRR	Regular	\$99.00	\$108.00	\$113.00	\$121.00
DRL	Light Wt.	\$118.00	\$124.00	\$137.00	\$150.00
DRG	LMG Lead-Free	\$128.00	\$148.00	\$196.00	\$220.00

DEMI•GUARD with BUCKLES

cat.#	lead type	small	medium	large	x-large
DBR	Regular	\$57.00	\$64.00	\$69.00	\$77.00
DBL	Light Wt.	\$71.00	\$85.00	\$97.00	\$104.00
DBG	LMG Lead-Free	\$95.00	\$114.00	\$141.00	\$168.00

DEMI•GUARD (Ring Set of 4 w/ Rack)

cat.#	lead type	price	size	(width x length)
DSR	Regular	\$620.00	S	(8" x 10")
DSL	Light Wt.	\$710.00	M	(12" x 12")
DSG	LMG Lead-Free	\$875.00	L	(16" x 14")
			X	(20" x 16")

DEMI•GUARD (Buckle Set of 4 w/ Rack)

cat.#	lead type	price	size	(width x length)
DGR	Regular	\$440.00	S	(8" x 10")
DGL	Light Wt.	\$545.00	M	(12" x 12")
DGG	LMG Lead-Free	\$705.00	L	(16" x 14")
			X	(20" x 16")

Gonadal•Guard Adult Gonadal Shields

- Attached belt with 1" buckle.
- 0.5mm Pb equivalency protection.
- Available in three sizes.



GONADAL•GUARD (individual)

cat.#	lead type	small	medium	large
GNR	Regular	\$31.00	\$36.00	\$42.00
GNL	Light Wt.	\$38.00	\$44.00	\$49.00
GNG	LMG Lead-Free	\$45.00	\$51.00	\$57.00

GONADAL•GUARD (set of all 3)

cat.#	lead type	price	size	(width x length)
GSR	Regular	\$99.00	S	(4" x 4 1/2")
GSL	Light Wt.	\$120.00	M	(6" x 7")
GSG	LMG Lead-Free	\$145.00	L	(7 1/2" x 9")

Diaper•Guard Adult Protective Diaper

- Specifically designed radiation protective diapers for adults.
- 0.5mm Pb equivalency protection.
- Convenient tie strings at each hip.



Gonadal•Guard Pediatric Gonadal Shields

- Specifically designed sets will accommodate neonatal up to small children.
- Gender appropriate gonadal shielding.
- 0.5mm Pb equivalency protection.



MALE (Blue/set of 4)

cat.#	lead type	price/set
GMR4	Regular	\$130.00
GML4	Light Wt.	\$175.00
GMG4	LMG Lead-Free	\$215.00



FEMALE (Pink/set of 5)

cat.#	lead type	price/set
GFR5	Regular	\$165.00
GFL5	Light Wt.	\$225.00
GFG5	LMG Lead-Free	\$280.00

Diaper•Guard Pediatric Protective Diaper

- Specifically designed radiation protective diapers accommodate infants up to small children.
- Color-coded regular lead diapers: small (red), medium (green), large (yellow)
- 0.5mm Pb equivalency protection.



cat.#	back x length x front	size	price
GBR-S	15 1/2"x13"x9"	small	\$69.00
GBR-M	12 1/2"x12"x7 1/2"	medium	\$79.00
GBR-L	9 1/2"x11"x5"	large	\$89.00
GBS-3	set of all 3	set of 3	\$225.00



Child•Guard Front Protection for Kids

EZ Fit, Front Protection

- Front protection apron with buckle closure.
- 0.5mm Pb equiv. front protection.
- Shoulder Pads: concealed for comfort and durability.
- Ideal for our younger patients, creating safer and more secure protection than lead drapes or shields.

CHILD•GUARD

cat.#	lead type	child
KGR	Regular	\$165.00
KGL	Light Wt.	\$245.00
KGG	LMG Lead-Free	\$310.00

size	(width x length)
Child	(18" x 24")



Kids Lap•Guard Half Apronette

- Easy-to-use 1" buckle belt closure.
- 0.5mm Pb equivalency protection.
- Excellent protection for small patients.
- Size "K" for Kids.



KIDS LAP•GUARD

cat.#	lead type	price
LKR	Regular	\$45.00
LKL	Light Wt.	\$55.00
LKG	LMG Lead-Free	\$85.00



Kiddie Kovers Kid-Friendly Protection

What makes Kiddie Kovers Unique:

- Decrease anxiety and fear with a "hug" from a friendly buddy.
- All purpose lead blanket protects children from radiation.
- 0.5mm Pb equivalency protection (regular lead only).
- Protective panel is 18" x 18" and safe for all modalities.

cat.#	description	price
KK-LBUG	Ladybug	159.00
KK-BBEE	Bumble Bee	159.00
KK-TURT	Turtle	159.00
KK-BFLY	Butterfly	159.00
KK-PUPP	Puppy	159.00
KK-FROG	Frog	159.00
KK-CATT	Cat	159.00
KK-MNKY	Monkey	159.00



Ladybug

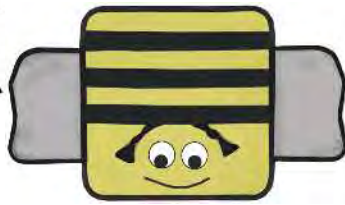

Bumble Bee



Turtle



Butterfly

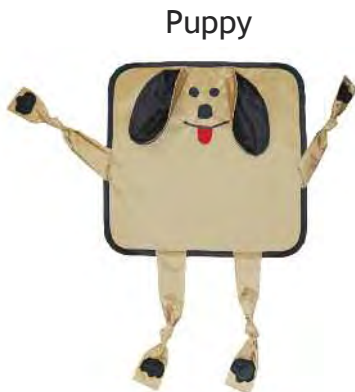

Puppy



Frog

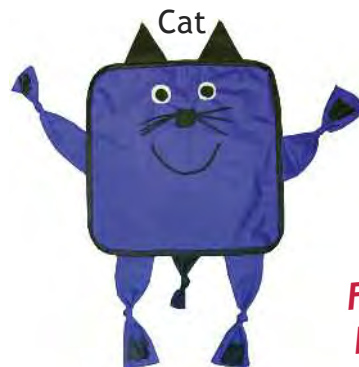

Cat



Monkey

**Four
New
Buddies!**

Protective Gloves and Mittens for General Radiology

Hand•Guard Protective Gloves

- Five fingered protection for full dexterity.
- Durable, soft navy vinyl covering (15").
- 0.5mm Pb equiv. dip-molded core.

HAND•GUARD 5-Finger

cat.#	hand	price
HGP	Pair	\$220.00
HGR	Right Hand	\$122.00
HGL	Left Hand	\$122.00



Palm•Guard

Protective Mittens (Slitted)

- Provides hand protection with option of exposing fingers for dexterity.
- Durable, soft navy vinyl covering (15").
- 0.5mm Pb equiv. dip-molded core.

PALM•GUARD Slitted

cat.#	hand	price
PSP	Pair	\$290.00
PSR	Right Hand	\$149.00
PSL	Left Hand	\$149.00



Finger•Guard Radiation Reducing Gloves

- Radiation for hands with outstanding tactile sensitivity.
- Protection from secondary radiation.
- Gives true freedom:
 - Lead-Free!
 - Latex-Free!
 - Powder-Free!
- Easy on, easy off with rolled and beaded cuff.
- Available in six sizes.



#PLF offers superior tactile sensitivity with excellent attenuation.



#PFC offers excellent tactile sensitivity with good attenuation.

cat.#	description	sizes	qty/pkg	price
PLF	.18mm Glove	6 1/2, 7, 7 1/2, 8, 8 1/2, 9	5 Pair	\$365.00
PFC	.23mm Glove	6 1/2, 7, 7 1/2, 8, 8 1/2, 9	5 Pair	\$249.00

ref. size	glove size
S	6 1/2, 7
M*	7 1/2, 8
L	8 1/2, 9

(*M = most common)

Attenuation for Finger•Guard - Broad Beam

Description	Cat.#	60 KvP	80 KvP	100 KvP	120 KvP
.18mm Glove	PLF	56.5%	47.1%	41.6%	37.7%
.23mm Glove	PFC	48.0%	40.0%	32.0%	28.0%

("mm" is actual thickness of glove in millimeters, NOT lead equivalency.)

Finger Guards offer Sterile Hand Protection!

Hat•Guard

Specify size:
Small - 21"
Medium - 22"
Large - 23 1/2"



- Protection for the top of head.
- Hook & Loop fitted closure.
- 0.50mm Pb equiv. sides,
0.25mm Pb equiv. top.

HAT•GUARD

cat.#	lead type	price
HCR	Regular	\$ 99.00
HCL	Light Wt.	\$125.00
HCG	LMG Lead-Free	\$150.00

Hood•Guard

One Size
Fits All.



- Long procedure protection.
- Covers the entire head.
- Hook & Loop closure.
- 0.5mm Pb equivalency.

HOOD•GUARD

cat.#	lead type	price
HOR	Regular	\$155.00
HOL	Light Wt.	\$175.00
HOG	LMG Lead-Free	\$195.00

Omni•Guard Protective Flexible Shield

- Used over a patient or equipment, protects from radiation exposure.
- Used underneath a patient, prevents scatter radiation.
- All purpose covering for patients or equipment.
- 0.5mm Pb equivalency protection.
- Choose any color fabric.



Custom Sizes Available

- **COLORS & FABRICS:** page 25.
- **Default Fabric:** Royal Blue nylon.
- **2-Year Limited Warranty.**



cat.#	lead type	small	medium	large	x-large
OMR	Regular	\$107.00	\$144.00	\$169.00	\$192.00
OML	Light Wt.	\$149.00	\$187.00	\$239.00	\$292.00
OMG	LMG Lead-Free	\$235.00	\$299.00	\$369.00	\$520.00

size	(width x length)
S	(18" x 18")
M	(24" x 24")
L	(24" x 36")
X	(24" x 48")

Belt•Guard Back Support Belt

#BGB
\$45.00



- Helps reduce back stress.
- Can be used with any apron.
- 6" elastic back support belt with 2" buckle closure.
- The same belt as used on the Ortho-Guard apron.

Guard•Tote Apparel Tote Bag

#ACB-28
\$99.00



- Convenient tote for all your protective wear.
- Durable rip-stop nylon fabric with zippered closure.
- 28" long to minimize folding your aprons.
- EZ-Carry handle and shoulder strap included.

Apron Super Wipes

- Use once, throw away, quick drying.
- Alcohol content: High @ 55%.
- Contains the highest range of effectiveness.
- Recommended Contact Time: 2-minutes or less.
- Great for cleaning and disinfecting **APRONS**.

#GWP-P55 \$12.50/each tub
#GWP-P55CS \$153.00/case of 12 tubs



Eye•Guard: radiation protective eyewear

Contour fit for ultra protection



ULTRA•GUARD

SILVER	BLACK	TAUPE	lens style	price
LER-9SPL	LER-9KPL	LER-9TPL	Non-Prescription	\$195.00
LER-9SSV	LER-9KSV	LER-9TSV	Single Vision Rx*	\$320.00
LER-9SBI	LER-9KBI	LER-9TBI	Bifocal Rx*	\$340.00

*(Prescription MUST accompany order. Progressive Lens Available. Non-returnable.)

Ultra•Guard

Ultra-light and super stylish.

- Curved lens adds to lateral protection.
- Regular hinges with wrap around frame.
- Universal bridge support.
- Available in most prescriptions.
- Includes premium case.
- Lead Equiv.: 0.75mm lens.
- Weight: 60 grams.
- Frame: impact resistant polycarbonate.



AVANT•GUARD

CARBON/GRAY	YELLOW/BLUE	PURPLE/GRAY	lens style	price
LER-ACPL	LER-AYPL	LER-APPL	Non-Prescription	\$195.00
LER-ACSV	LER-AYSV	LER-APSV	Single Vision Rx*	\$320.00
LER-ACBI	LER-AYBI	LER-APBI	Bifocal Rx*	\$340.00

*(Prescription MUST accompany order. Progressive Lens Available. Non-returnable.)

Avant•Guard

Two-tone colorful Ultra•Guards.

- Curved lens adds to lateral protection.
- Regular hinges with wrap around frame.
- Universal bridge support.
- Available in most prescriptions.
- Includes premium case.
- Lead Equiv.: 0.75mm lens.
- Weight: 60 grams.
- Frame: impact resistant polycarbonate.



COLOR•GUARD

RED	BLUE	ORANGE	lens style	price
LER-CRPL	LER-CBPL	LER-COPL	Non-Prescription	\$195.00
LER-CRSV	LER-CBSV	LER-COSV	Single Vision Rx*	\$320.00
LER-CRBI	LER-CBBI	LER-COBI	Bifocal Rx*	\$340.00

*(Prescription MUST accompany order. Progressive Lens Available. Non-returnable.)

Color•Guard

Bright-tone colorful Ultra•Guards.

- Curved lens adds to lateral protection.
- Regular hinges with wrap around frame.
- Universal bridge support.
- Available in most prescriptions.
- Includes premium case.
- Lead Equiv.: 0.75mm lens.
- Weight: 60 grams.
- Frame: impact resistant polycarbonate.

Eye•Guard: radiation protective eyewear

Contemporary designs for style and comfort



POWER•GUARD

BLUE/ORANGE	SILVER/PINK	BLACK/GRAY	lens style	price
LER-PBPL	LER-PSPL	LER-PKPL	Non-Prescription	\$215.00
LER-PBSV	LER-PSSV	LER-PKSV	Single Vision Rx*	\$340.00
LER-PBBI	LER-PSBI	LER-PKBI	Bifocal Rx*	\$360.00

*(Prescription MUST accompany order. Progressive Lens Available. Non-returnable.)

Power•Guard

Colortone accents increase comfort.

- Large lens area for excellent coverage.
- Soft colored endpiece for comfort and fit.
- Padded bridge, temples, and endpiece.
- Available in most prescriptions.
- Includes premium case.
- Lead Equiv.: 0.75mm lens.
- Weight: 64 grams.
- Frame: impact resistant polycarbonate.



TURBO•GUARD

RED	BLACK	SILVER	lens style	price
LER-TRPL	LER-TKPL	LER-TSPL	Non-Prescription	\$195.00
LER-TRSV	LER-TKSV	LER-TSSV	Single Vision Rx*	\$320.00
LER-TRBI	LER-TKBI	LER-TSBI	Bifocal Rx*	\$340.00

*(Prescription MUST accompany order. Progressive Lens Available. Non-returnable.)

Turbo•Guard

For that sharp and stream-lined look.

- Large lens area for excellent coverage.
- Rubberized temple bars for comfortable grip.
- Rubber, ultra-soft, fixed nose pad.
- Available in almost all prescriptions.
- Includes premium case.
- Lead Equiv.: 0.75mm lens.
- Weight: 65 grams.
- Frame: impact resistant nylon.



SURE•GUARD

SILVER	BLACK	RED	lens style	price
LER-6SPL	LER-6KPL	LER-6RPL	Non-Prescription	\$195.00
LER-6SSV	LER-6KSV	LER-6RSV	Single Vision Rx*	\$320.00
LER-6SBI	LER-6KBI	LER-6RBI	Bifocal Rx*	\$340.00

*(Prescription MUST accompany order. Progressive Lens Available. Non-returnable.) (ultra-soft bridge)



Sure•Guard

Stylish design for medium faces.

- Large lens area for excellent coverage.
- Regular hinges with wrap around frame.
- Rubber, ultra-soft, fixed nose piece.
- Available in almost all prescriptions.
- Includes premium case.
- Lead Equiv.: 0.75mm lens.
- Weight: 63 grams.
- Frame: impact resistant plastic.

Eye•Guard: radiation protective eyewear

Stylish designs that will set you apart



New Colors!

WRAP•GUARD

Tortoise	Green	Crimson	Purple	Blue	lens style	price
LES-53PLT	LES-53PLG	LES-53PLC	LES-53PLP	LES-53PLB	Non-Prescription	\$215.00
LES-53SVT	LES-53SVG	LES-53SVC	LES-53SVP	LES-53SVB	Single Vision Rx*	\$340.00
LES-53BIT	LES-53BIG	LES-53BIC	LES-53BIP	LES-53BIB	Bifocal Rx*	\$360.00

*(Prescription MUST accompany order. Progressive Lens Available. Non-returnable.)

Wrap•Around

The “original” with great side protection.



- Generous lens area increases protection.
- Spring hinges and adjustable nose.
- Available in most prescriptions.
- Includes premium case.
- Lead Equiv.: 0.75mm lens.
- Frame: impact resistant plastic.



VIVA•GUARD

FANCY FLIGHT	CHERRY VINES	RAD SKULL	lens style	price
LER-VFPL	LER-VVPL	LER-VSPL	Non-Prescription	\$215.00
LER-VFSV	LER-VVSV	LER-VSSV	Single Vision Rx*	\$340.00
LER-VFBI	LER-VVBI	LER-VSBI	Bifocal Rx*	\$360.00



*(Prescription MUST accompany order. Progressive Lens Available. Non-returnable.) (ultra-soft bridge)

Viva•Guard

Lively designs for small to medium faces.

- Smaller frame for excellent fit of smaller faces.
- Regular hinges with wrap around frame.
- Ultra soft bridge support.
- Available in most prescriptions.
- Includes premium case.
- Lead Equiv.: 0.75mm lens.
- Weight: 60 grams.
- Frame: impact resistant polycarbonate.



NEW!

JACKIE-O•GUARD

Crystal Blue	Green Tea	lens style	price
LER-JBPL	LER-JGPL	Non-Prescription	\$310.00
LER-JBSV	LER-JGSV	Single Vision Rx*	\$495.00
LER-JBBI	LER-JGBI	Bifocal Rx*	\$575.00

*(Prescription MUST accompany order. Non-returnable)

Jackie-O•Guard

Stylish frame with big vision.

- Attractive and sturdy women's frames.
- Large lens area increases protection.
- Excellent visibility.
- Available in most prescriptions.
- Includes premium case.
- Lead Equiv.: 0.75mm lens.
- Weight: 70 grams.
- Frame: impact resistant plastic.

Eye•Guard: radiation protective eyewear

Specialty eye and face protection



Cover•Guard

Comfortable protection over regular glasses.

- Excellent front and side visibility.
- Provides limited splash protection.
- Can be worn over prescription eyewear.
- Regular hinges with molded nose piece.
- Includes 0.75mm Pb glass side shields.
- Includes premium case.
- Lead Equiv.: 0.75mm front and sides.
- Weight: 85 grams.
- Frame: black rubberized nylon.

COVER•GUARD

BLACK	WHITE	TORTOISE	lens style	price
LES-CKPL	LES-CWPL	LES-CTPL	Non-Prescription	\$150.00



Wire•Guard

Classic light-weight wire frame glasses.

- Offers the best protection on a metal frame.
- Tapered endpiece and adjustable bridge.
- Super lightweight for medium to large faces.
- Available in most prescriptions.
- Includes premium case.
- Lead Equiv.: 0.75mm lens.
- Weight: 60 grams.
- Frame: metal wire frames.

WIRE•GUARD

Black	Silver	lens style	price
LER-WKPL	LER-WSPL	Non-Prescription	\$195.00
LER-WKSV	LER-WSSV	Single Vision Rx*	\$320.00
LER-WKBI	LER-WSBI	Bifocal Rx*	\$340.00

*(Prescription MUST accompany order. Non-returnable)



Visor•Guard

Front or panoramic face protection.

- Broadest range of head and facial protection.
- Eliminates blind spots caused by glasses frames.
- Allows standard glasses to be worn underneath.
- Adjustable headband keeps visor securely on head and prevents slippage.
- Flip-up visor is out of the way until needed.
- Lead Equiv.: 0.1mm.
- Weight: Full 467 grams / Panoramic 417 grams
- Frame: impact resistant plastic; gray.

VISOR•GUARD Full Face

cat.#	lens style	price
LES-VGFF	Full Face Shield	\$640.00

VISOR•GUARD Panoramic

cat.#	lens style	price
LES-VGPN	Panoramic Shield	\$590.00



Aprons not included.

Mobile Apron Rack

Standard Mobile Rack	Standard WITH Glove Rack
#ARM-100	#ARM-G60
\$895.00	\$965.00

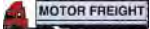
- Ten (10) swing-arm mobile garment stand.
- Durable all-steel construction.
- 24" x 24" H-Base for stability and easy cleaning.
- E-Z-Roll swivel locking casters.
- Convenient handle for easy mobility.
- Neutral Almond baked enamel finish.
- Overall height is 55".
- Some assembly required.
- Ships @ 110 lb. 



Arms swing inward to conserve space.

**New:
Easy-Clean
H-Base!**

Wall Mounted Apron Racks



10-ARM #ARW-10 \$340.00



5-ARM, SWING LEFT #ARW-L5 \$199.00



5-ARM, SWING RIGHT #ARW-R5 \$199.00

- Ten (10) or five (5) swing-arm wall-mount apron racks.
- Mounting holes on 16" centers.
- All-steel durability.
- Almond enamel finish. 
- 10-Arm Ships @ 25 lb. / 5-Arm Ships @ 17 lb.

Glove Adapter

- Retrofits to Mobile Rack.
- Mounted on 16" centers.
- Holds six (6) 18" gloves.
- Ships @ 8 lb.

#ARG-06
\$75.00



24" Wall Adapter

- Allows wall racks with only 16" mounting centers to be mounted on 24" wall studs.
- All-steel, Almond finish, 8" tall x 28" long.
- Ships @ 10 lb.

#AGA-24
\$55.00



Designed for: #ARG-06,
#ARW-10, #ARW-L5, ARW-R5

Apron/Glove Racks

- Designed for one apron, but will hold more.
- All steel, heavy duty construction.
- 16" & 24" mounting holes match most wall studs.
- Glove holders mounted onto back panel.
- 28½" long x 1¾" diameter bar prevents creasing.
- Ships @ 13 lbs.



Aprons not included.

Rack without Glove Holders
#AGR-105 \$145.00



Rack with Two Glove Holders
#AGR-110 \$195.00



Rack with Four Glove Holders
#AGR-115 \$245.00

Apron Peg Racks

- 6" pegs are angled to keep garments from slipping.
- Mounting holes on the 6-peg and 8-peg racks are on both 16" and 24" centers.
- All-steel Almond enamel finish.



2-peg

(for 1 apron)

#ARP-02
\$53.00

Ships @ 4 lb



*If you need security,
ask about our apron
rack locking systems.*

6-peg

(for 3 aprons)

#ARP-06
\$110.00

Ships @ 10 lb



Mounting holes on 16" and 24" centers.

8-peg

(for 4 aprons)

#ARP-08
\$135.00

Ships @ 11 lb



Mounting holes on 16" and 24" centers.

Best-Fit Sizing Charts

Front Protection Apron

size	width	length	fits chest
Petite	18"	30"	< 36"
Small	20"	32"	< 40"
Medium	22"	36"	< 44"
Large	24"	38"	< 48"
X-Large	26"	40"	< 52"
2X	28"	40"	< 56"
3X	30"	40"	< 60"

Sizes shown for apparel *other than* Front Protection are actual body measurements.

All **lengths** are from the sternal notch or waist downward, depending on the garment.

Full Wrap Around Protection

size	chest	waist	length
Petite	30"-32"	32"-34"	34"
Small	32"-36"	35"-38"	36"
Medium	36"-40"	38"-41"	36"
Large	40"-44"	42"-45"	38"
X-Large	44"-48"	46"-49"	40"
2X	48"-54"	50"-53"	40"
3X	54"-58"	54"-57"	40"

Vest (female)

size	bust	waist	hip	length
Petite	33"-34"	< 31"	35"-36"	19"
Small	35"-36"	< 33"	37"-38"	19 1/2"
Medium	37"-38"	< 35"	39"-40"	20"
Large	39"-41"	< 39"	41"-43"	21"
X-Large	42"-44"	< 41"	44"-46"	22"
2X	45"-49"	< 46"	47"-51"	23"
3X	50"-54"	< 51"	52"-56"	23"

Vest (male)

size	chest	length
Petite	35"-36"	19 1/2"
Small	37"-38"	20"
Medium	39"-41"	21"
Large	42"-44"	22"
X-Large	45"-49"	23"
2X	50"-54"	24"
3X	55"-59"	24"

Skirt / Kilt

size	waist	hip	length
Petite	25"-27"	32"-34"	19"
Small	28"-29"	35"-36"	19"
Medium	30"-33"	37"-40"	20"
Large	34"-37"	41"-44"	21"
X-Large	38"-41"	45"-48"	22"
2X	42"-45"	49"-52"	22"
3X	46"-50"	53"-57"	22"

We have revamped our patterns and sizes to assure you a confident fit!

Stock and Custom Embroidery

In addition to our FREE name embroidery and monogramming, we offer a selection of over 5,000 embroidery images for your protective garment. Give us a call with your ideas and, together, we'll create a solution just for you.



LG1357



3D0003



CH0477



FL0469



MI0387



LG0689



MI1273



HY0670



MI2261



LG0571



LG0561



LG0577



MI1883



CH0059



LG0506

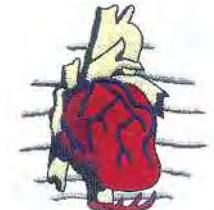

LG0554



LG0553



LG0051

Getting the Best-Fit

If you don't think that our standard sized garments will fit you properly, we are pleased to offer you the chance to create your own size, to fit your specific body measurements. Just complete the form below and we will create your customized protective wear. Please note, that due to the nature of customized apparel, these garments cannot be returned. *Please be accurate.* Thanks!

NAME _____

FACILITY _____

ADDRESS 1 _____ ADDRESS 2 _____

CITY _____ STATE _____ ZIP _____

DAYTIME PHONE _____ EMAIL _____

APRON CAT.# _____ DESCRIPTION _____ LEAD TYPE _____

FABRIC (p25) _____ BINDING COLOR (p24) _____

EMBROIDERY (OPTIONAL) LINE 1, UP TO 24-LETTERS (FREE) _____

EMBROIDERY LINE 2, UP TO 24-LETTERS (\$10.00) _____

EMBROIDERY THREAD COLOR (p24) _____ LETTER STYLE (p24) _____

ADD ATTACHED THYROID COLLAR? YES NO CAT.# _____ (COLOR WILL MATCH APRON)

SPECIAL COMMENTS _____

Getting Accurate Measurements *(all in inches)*

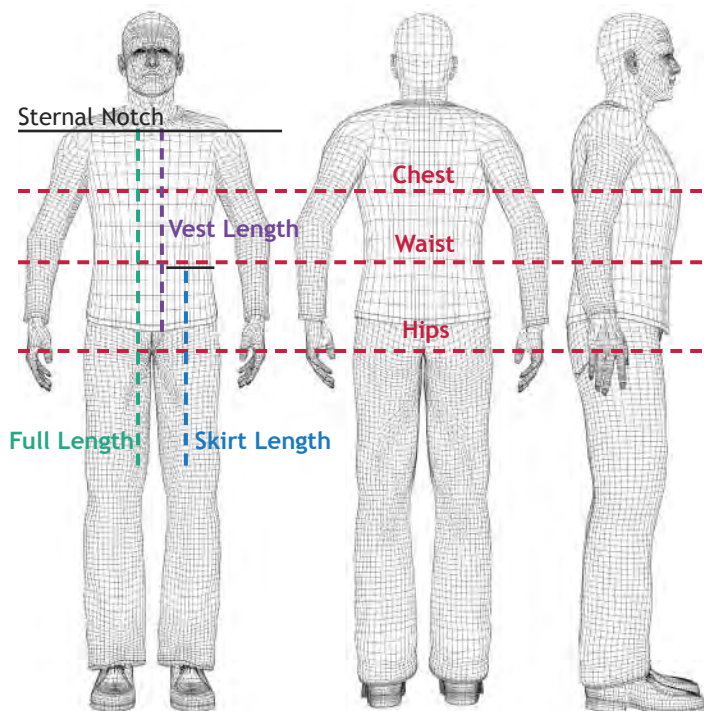

BUST/CHEST: _____
Circumference around the widest part of your chest.

WAIST: _____
Standard Apron: measure your waistline.
Skirt/Kilt: measure where you want the skirt/kilt top (may be higher than your regular waistline).

HIP: _____
Circumference around the widest part of your hips.

LENGTH:
FRONT APRON or WRAP-AROUND: _____
Sternal notch to just above the knee.

VEST: _____ + 2" = _____
Sternal Notch to top of skirt/kilt, plus 2" overlap.

SKIRT/KILT: _____
Desired skirt/kilt top (may be above your regular waistline) to just above your knee.

Please photocopy this page to submit your order.

Embroidery Sewn-In

- Selected garments come with first line FREE embroidery!
- Add flexibility with an embroidered patch.
- Please specify what you want embroidered and which type style you prefer (see below).
- Embroidered items are non-returnable, non-refundable.

First Line up to 24-Letters: **\$FREE!** Select a Style:

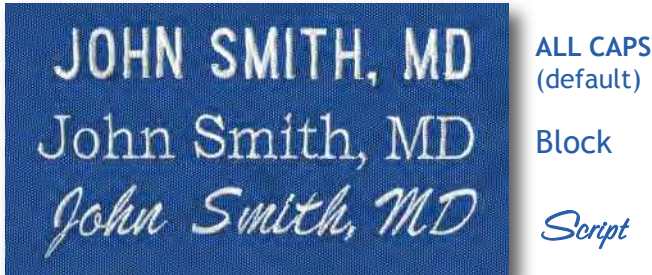

ALL CAPS
(default)

Block

Script

Additional lines up to 24-letters: \$10.00

Embroidery Add-On Patch

This flexible option has your information embroidered onto a patch. Hook & Loop on the back of the patch and on the garment secure the patch in place.

#EMP (Patch) \$18.00



(Patch above pocket)



Accent Colors

Optional BINDING Colors:

Black (default)	Red
Lt. Gray (default)	Yellow
Navy	Orange
Royal Blue	Tan

(The black or gray stripe on each fabric square is the default binding color for that fabric.)

Optional EMBROIDERY Colors:

White (default)	Red
Black (default)	Yellow
Lt. Gray	Orange
Charcoal	Tan
Royal Blue	Brown

Things to Remember

CARE AND MAINTENANCE:

- Always hang your garment on large diameter hangers. Do not wad or fold your garment, as that may weaken the level of protection on the folded seam.
- Do not store sharp objects in the pockets or store the garment on top of a sharp object.

WARRANTY:

- Two-Year Warranty on materials and workmanship.

Shoulder Strap (*FREE Option!*)



#EMS
\$-No Charge!

- Simply ask for it with your order.
- Hook & loop Strap is attached to one shoulder and reaches across to the other.
- Helps keep shoulders high and comfortable.



Recycle

- Techno-Aide will gladly accept your old, leaded **Techno-Aide Brand** aprons for recycling.
- Call for a "Recycle Return Authorization." There will be no charge to you; we only ask that you pay for your own shipping.
- "Lead-Free" apparel is environmentally friendly and does not need to be recycled.

Nylons and Polyester Prints Liquid Repellent

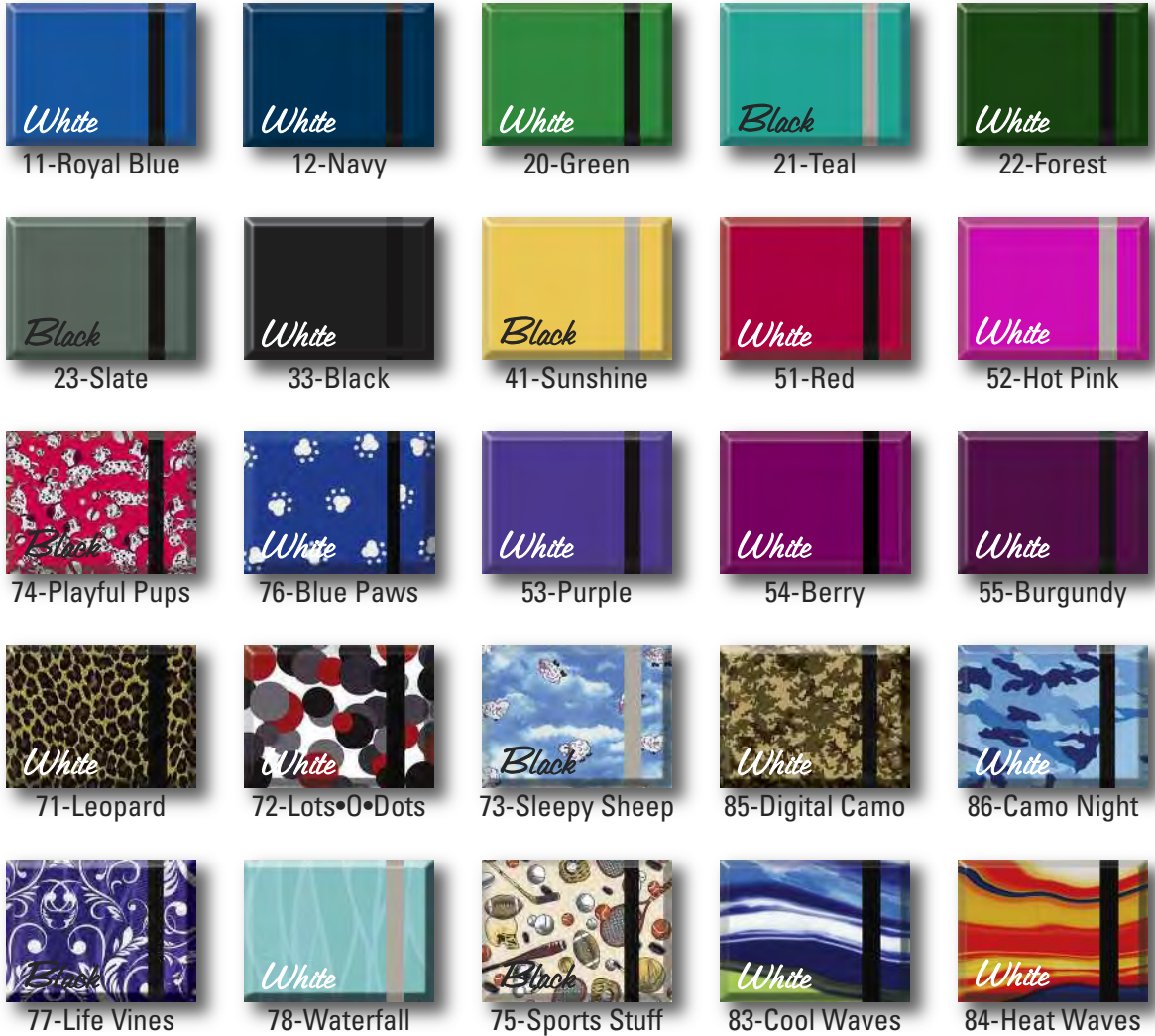

(NOTE: Prints are shown SMALLER than actual size)

Ripstop Nylon Filament Reinforced Diamond Polyester



Galaxy Prints High Sheen Liquid Proof Polyurethane Laminate



High-Tech Fabrics Textured





#PBMW-2472
(Call for Price)
Leaded Glass: 10"w x 12"h
Overall Size: 24"w x 72"h
Ships @ 350 lbs.



#PBMW-3072
(Call for Price)
Leaded Glass: 10"w x 12"h
Overall Size: 30"w x 72"h
Ships @ 450 lbs.



#PBMW-3672
(Call for Price)
Leaded Glass: 10"w x 12"h
Overall Size: 36"w x 72"h
Ships @ 450 lbs.

Viewing Window Barriers



#PBMW-2484
(Call for Price)
Leaded Glass: 10"w x 12"h
Overall Size: 24"w x 84"h
Ships @ 450 lbs.



#PBMW-3084
(Call for Price)
Leaded Glass: 10"w x 12"h
Overall Size: 30"w x 84"h
Ships @ 450 lbs.

Bring a full **2.0mm Pb Equivalency** of radiation protection anywhere you need it with our x-ray protective mobile barriers.

Each Barrier features:

- 10"w x 12"h clear window made of x-ray protective leaded glass;
- Window center is 60" from the bottom of the panel.
- Opaque barrier section is made of solid, leaded x-ray protection;
- Locking caster system for easy mobility (it is recommended that two people move the barrier for safety);
- Crated for secure shipment.
- NOTE: 84" barriers may not fit through some doorways.

Techno-Shield: Real Stopping Power!

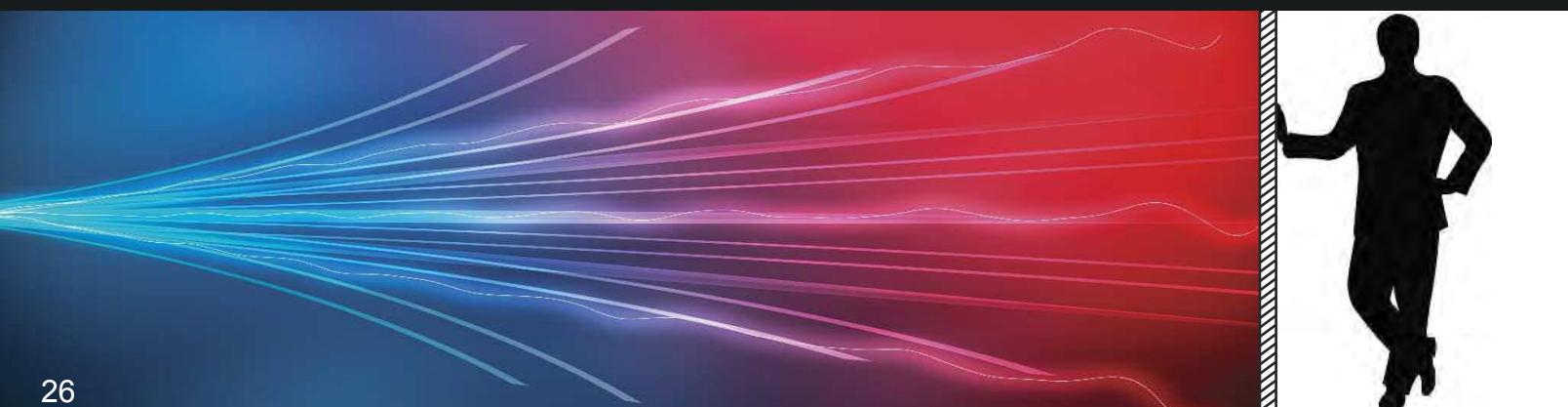

Techno-Shield Mobile Barriers



#PBMB-3024
(Call for Price)
Leaded Glass: 30"w x 24"h
Opaque Panel: 30"w x 48"h
Overall Size: 33"w x 75"h
Ships @ 450 lbs.



#PBMB-3060
(Call for Price)
Leaded Glass: 30"w x 60"h
Opaque Panel: 30"w x 12"h
Overall Size: 33"w x 75"h
Ships @ 450 lbs.

Viewing Panel Barriers

Bring a full 2.0mm Pb Equivalency of radiation protection anywhere you need it with our x-ray protective mobile barriers.

Each Barrier features:

- Transparent/clear upper section of x-ray protective leaded glass;
- Opaque lower section of solid, leaded x-ray protection;
- Locking caster system for easy mobility (it is recommended that two people move the barrier for safety);
- Crated for secure shipment.



#PBMB-4830
(Call for Price)
Leaded Glass: 48"w x 30"h
Opaque Panel: 48"w x 42"h
Overall Size: 51"w x 75"h
Ships @ 450 lbs.



#PBMB-4836
(Call for Price)
Leaded Glass: 48"w x 36"h
Opaque Panel: 48"w x 36"h
Overall Size: 51"w x 75"h
Ships @ 650 lbs.



#PBMB-7236
(Call for Price)
Leaded Glass: 72"w x 36"h
Opaque Panel: 72"w x 36"h
Overall Size: 75"w x 75"h
Ships @ 700 lbs.

A mobile barrier should offer greater protection than an apron. Techno-Shield provides **2.0mm Pb Equivalency** protection!

Leaded Glass panels by **Schott**, the world leader in protection and quality.

Standard Shield

- 0.5mm Pb equivalency.
- Shield area: 24" x 24", 36", or 48".
- Adjustable height: 36" to 60".
- Stable, five-legged star base.
- Default color: royal blue.

cat.#	shield style	width x height	price
LPS-S2424	solid	24" x 24"	\$520.00
LPS-S2436	solid	24" x 36"	\$555.00
LPS-S2448	solid	24" x 48"	\$590.00



Deluxe Shield

- 0.5mm Pb equivalency.
- Shield area: 30" x 30" or 42".
- Adjustable height: 36" to 60".
- Steady all steel T-base.
- Hardened chrome steel post.
- **Posi-Lock** height adjustable arm with spring-loaded pin.
- Default color: royal blue.

cat.#	shield style	width x height	price
LPS-T3030S	solid	30" x 30"	\$645.00
LPS-T3030P	5-panel	30" x 30"	\$695.00
LPS-T3042S	solid	30" x 42"	\$695.00
LPS-T3042P	5-panel	30" x 42"	\$795.00



Max-Shield

- 0.5mm Pb equivalency.
- Shield area: 36" x 36" or 48" x 48".
- Adjustable height: 36" to 60".
- All steel H-base for maximum stability.
- Hardened chrome steel post.
- **Posi-Lock** height adjustable arm with spring-loaded pin.
- Default color: royal blue.

cat.#	shield style	width x height	price
LPS-H3636	solid	36" x 36"	\$850.00
LPS-H4848	solid	48" x 48"	\$950.00

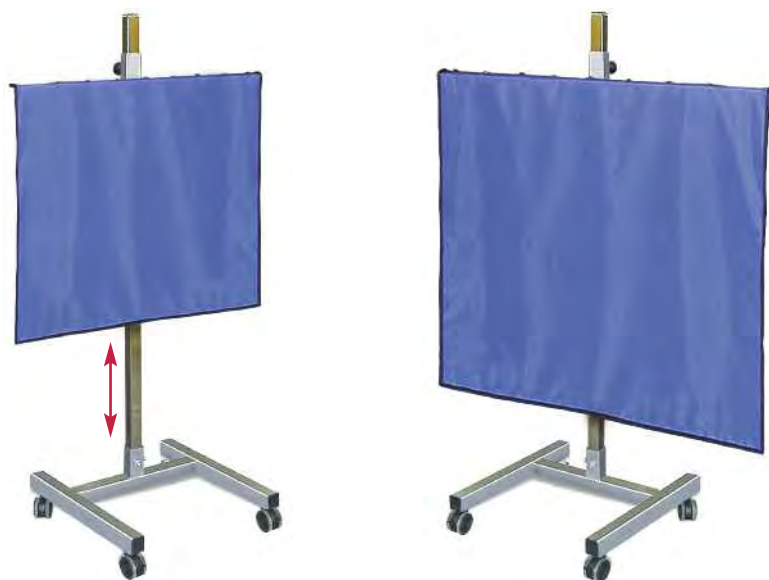

Table Drape Shielding

- Protect staff from scatter radiation without obstructing the C-Arm.
- 0.5mm Pb equivalency.
- Attaches with hook & loop (all included).
- Order two for double-sided use.
- Available in three widths: 24", 36" and 48".
- Mix sizes to fill desired width of coverage.
- Available in three heights: 24", 30" and 36".
- Default color: royal blue.



*Personal Option:
Choose Your
Fabric (p.25)!*

Main Drape

cat.#	panel count	width x height	price
TDP-2424	4-panels	24" x 24"	\$295.00
TDP-2430	4-panels	24" x 30"	\$395.00
TDP-2436	4-panels	24" x 36"	\$495.00
TDP-2442	4-panels	24" x 42"	\$595.00
TDP-3024	5-panels	30" x 24"	\$395.00
TDP-3030	5-panels	30" x 30"	\$429.00
TDP-3036	5-panels	30" x 36"	\$449.00
TDP-3042	5-panels	30" x 42"	\$549.00
TDP-3624	6-panels	36" x 24"	\$349.00
TDP-3630	6-panels	36" x 30"	\$449.00
TDP-3636	6-panels	36" x 36"	\$549.00
TDP-3642	6-panels	36" x 42"	\$649.00
TDP-4824	8-panels	48" x 24"	\$495.00
TDP-4830	8-panels	48" x 30"	\$595.00
TDP-4836	8-panels	48" x 36"	\$695.00
TDP-4842	8-panels	48" x 42"	\$795.00
TDP-CUST	Custom	Choose	Call

Anesthesia Drape

cat.#	panel count	width x height	price
TDP-2024	3-panels	20" x 24"	\$250.00
TDP-2030	3-panels	20" x 30"	\$350.00
TDP-2036	3-panels	20" x 36"	\$450.00
TDP-2042	3-panels	20" x 42"	\$550.00
TDP-2224	4-panels	22" x 24"	\$275.00
TDP-2230	4-panels	22" x 30"	\$375.00
TDP-2236	4-panels	22" x 36"	\$475.00
TDP-2242	4-panels	22" x 42"	\$575.00
TDP-CUST	Custom	Choose	Call

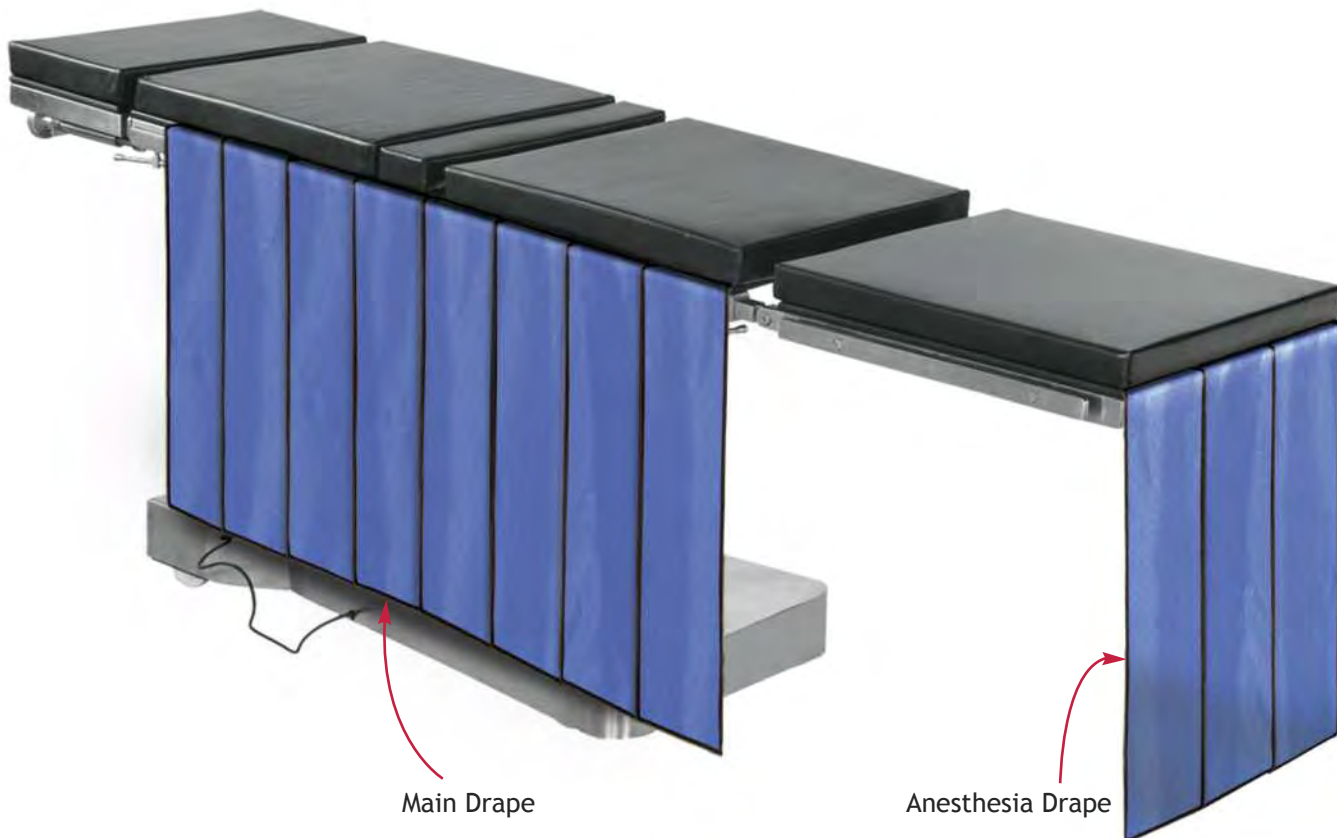

CR Cart Drapes

- Protect receptor plates from scatter radiation.
- Specifically designed for the Agfa CR-30X cart or models of equal design and size.
- Provides 0.5mm Pb Equivalency shielding.
- Complete kit includes the four panels shown below, plus three 36" self-adhesive "loop" strips with which to easily attach the panels to the cart.
- Choose from dozens of fabric design and color options.



Complete 4-Panel Kit
(see sizes below)

#TDP-C30
\$1320.00



*Protection
from
Scatter
Radiation!*



Left Side Panel
(#TDP-3628)
6-flaps @ 36" w x 28" h



Front Panel
(#TDP-3628)
6-flaps @ 36" w x 28" h



Right Side Panels
(#TDP-2728)
4-flaps @ 27" w x 28" h
(#TDP-0528)
1-flap @ 5" w x 28" h

Lead Blockers

- Maximize efficiency and optimize use of receptors.
- Divides receptor for multiple exposures.
- Covered with blue vinyl laminate.
- Flexible vinyl-lead positions easily.
- Cleans easily with most common disinfectants.
- Provides 1.0mm Pb Equivalency shielding.



cat.#	blocker size	fits receptor	price
FLB-58	5" x 8" (13x18cm)	8 x 10	\$35.00
FLB-52	5" x 12" (13x30cm)	10 x 12	\$45.00
FLB-61	6" x 10" (15x24cm)	10 x 12	\$45.00
FLB-71	7" x 11" (18x28cm)	11 x 14	\$55.00
FLB-77	7" x 17" (18x43cm)	14 x 17	\$80.00
FLS-78	set of all FIVE	Save 10%	\$234.00



Lead-Lined Wall Bin

- Protect your investment when plates are not in use.
- Solid steel construction with vinyl-lead lining.
- Provides 1.0mm Pb Equivalency shielding.
- Specifically designed for receptor plates.
- Opening is 22"w x 5"d x 14"h.



Lead-Lined with shielded body.

#80LL
\$960.00

Wall Bin overall size:
22"w x 5³/₈"d x 22"h
Shipping weight: 25 lbs.

Lead-Lined Table-Top Bin

- Store multiple receptors without worry of scatter radiation.
- 14-gauge welded steel construction with vinyl-lead lining.
- Provides 1.0mm Pb Equivalency shielding from scatter.
- Bumper guards protect receptors from impact damage.
- Opening is 16"w x 19"d x 20"h.

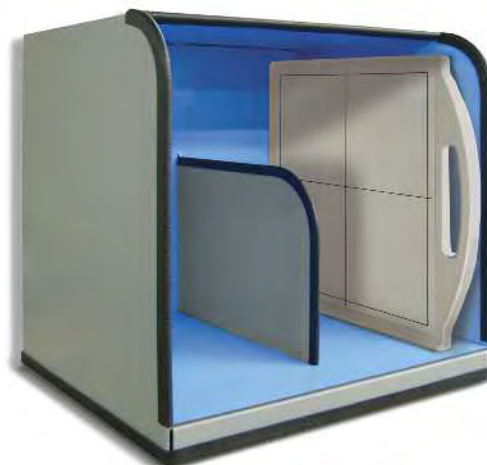

Lead-Lined with shielded body.

#CPH-LL12
\$1495.00

Unit above with shielded door:
#CPH-LD12
\$1995.00



Standard Wheelchair

Efficient, cost-effective solution to meet most needs.

- 250-lb weight capacity - evenly distributed.
- Two-position axle and caster fork provide 2" seat height adjustment.
- Industry compatible "Tool Free" adjustable front rigging.
- Black vinyl upholstery with chart pocket on the back.
- 1-Year limited warranty on side frames and crossbars.
- Meets Medicare code K0001 and K0002.

cat.#	width	arm style	leg/foot style	price
BBWI-SA22	18"	detachable desk	swinging foot	\$285.00
BBWI-SA23	18"	detachable desk	elevating leg	\$315.00
BBWI-SA24	18"	detachable full	swinging foot	\$285.00
BBWI-SA25	18"	detachable full	elevating leg	\$315.00
BBWI-SA26	20"	detachable desk	swinging foot	\$300.00
BBWI-SA27	20"	detachable desk	elevating leg	\$325.00
BBWI-SA28	20"	detachable full	swinging foot	\$300.00
BBWI-SA29	20"	detachable full	elevating leg	\$325.00

Seat			Back	Overall				Wt.
18"	16"	18" or 20"	15 1/2"	31 1/2"	35 1/2"	26 1/2"	12"	40#
20"	16"	18" or 20"	15 1/2"	31 1/2"	35 1/2"	28 1/2"	12"	40#

Accessories & Definitions, p.35



Advantage Wheelchair

Designed for durability, comfort, and low maintenance.

- 250-lb weight capacity - evenly distributed.
- Carbon steel frame for strength and durability.
- Industry compatible "Tool Free" adjustable front rigging.
- Black vinyl upholstery with chart pocket on the back.
- 1-Year limited warranty on side frames and crossbars.
- Meets Medicare code K0001.

cat.#	width	arm style	leg/foot style	price
BBWI-AA10	18" ^A	detachable desk	swinging foot	\$235.00
BBWI-AA11	18" ^A	detachable desk	elevating leg	\$260.00
BBWI-AA12	18" ^B	detachable full	swinging foot	\$225.00
BBWI-AA13	18" ^B	detachable full	elevating leg	\$260.00
BBWI-AA14	20"	detachable desk	swinging foot	\$250.00
BBWI-AA15	20"	detachable desk	elevating leg	\$275.00
BBWI-AA16	20"	detachable full	swinging foot	\$250.00
BBWI-AA17	20"	detachable full	elevating leg	\$275.00

Seat			Back	Overall				Wt.
18" ^A	16"	19 1/2"	16 1/2"	32"	36"	26 1/2" ^A	11 1/2"	40#
18" ^B	16"	19 1/2"	16 1/2"	32"	36"	28 1/2" ^B	11 1/2"	40#
20"	16"	19 1/2"	16 1/2"	32"	36"	30 1/2"	11 1/2"	41#



Heavy Duty Wheelchair

Double crossbraces and 5/8" axles stand for heavy duty.

- 500-lb weight capacity - evenly distributed.
- Reinforced frame at all load-bearing points.
- Two-position axle and caster fork provide 2" seat height adjustment.

cat.#	width	arm style	leg/foot style	price
BBWI-HD50	20"	detachable desk	swingaway foot	\$475.00
BBWI-HD51	20"	detachable desk	elevating leg	\$500.00
BBWI-HD52	20"	detachable full	swingaway foot	\$475.00
BBWI-HD53	20"	detachable full	elevating leg	\$500.00
BBWI-HD54	22"	detachable desk	swingaway foot	\$485.00
BBWI-HD55	22"	detachable desk	elevating leg	\$515.00
BBWI-HD56	22"	detachable full	swingaway foot	\$485.00
BBWI-HD57	22"	detachable full	elevating leg	\$515.00
BBWI-HD58	24"	detachable desk	swingaway foot	\$500.00
BBWI-HD59	24"	detachable desk	elevating leg	\$525.00
BBWI-HD60	24"	detachable full	swingaway foot	\$500.00
BBWI-HD61	24"	detachable full	elevating leg	\$525.00

- Industry compatible "Tool Free" adjustable front rigging.
- Black vinyl upholstery with double liner and chart pocket on the back.
- 5-Year limited warranty on side frames and crossbars.
- Meets Medicare code K0007.

Seat			Back	Overall				Wt.
20"	18"	18" or 20"	16 1/2"	34"	36"	28 1/2"	12 1/2"	57#
22"	18"	18" or 20"	16 1/2"	34"	36"	30 1/2"	12 1/2"	57#
24"	18"	18" or 20"	16 1/2"	34"	36"	32 1/2"	12 1/2"	57#

Accessories & Definitions, p.35



Lightweight Transporter

Aluminum frame is easy to lift and store.

- 250-lb weight capacity - evenly distributed.
- Fold-down back makes transport and storage easy.
- Industry compatible "Tool Free" adjustable front rigging.
- Black vinyl upholstery is flame retardant.
- 1-Year limited warranty on frame and crossbars.
- Available in six colors.
- Meets Medicare code E1038.

cat.#	color	price
BBWI-TASB	Blue	\$225.00
BBWI-TASR	Red	\$225.00
BBWI-TASP	Pink	\$225.00
BBWI-TASA	Aqua	\$225.00
BBWI-TASG	Green	\$225.00
BBWI-TASS	Silver	\$225.00

Seat			Back	Overall				Wt.
19"	16"	19"	18"	35"	39"	24"	10"	20#





Bariatric Wheelchair

Engineered to be safe & comfortable for the bariatric user.

- 650-lb weight capacity - evenly distributed.
- Reinforced welds and gussets on the frame.
- 24" solid rear wheels and 8"x2" solid casters.
- Black reinforced nylon upholstery.
- Limited Lifetime Warranty on side frames and crossbars.
- Meets Medicare code K0007.

[Accessories & Definitions, p.35](#)

cat.#	width	arm style	leg/foot style	price
BBWI-HD65	26"	fixed desk	swingaway foot	\$1325.00
BBWI-HD66	26"	fixed desk	elevating leg	\$1475.00
BBWI-HD67	30"	fixed desk	swingaway foot	\$1700.00
BBWI-HD68	30"	fixed desk	elevating leg	\$1850.00



Seat			Back	Overall				Wt.
26"	19 1/2"	20 1/2"	18 1/2"	49"	39"	35 1/2"	14 1/2"	70#
30"	19 1/2"	20 1/2"	18 1/2"	49"	39"	40"	14 1/2"	75#

Bariatric Transporter

Designed for strength, comfort, and durability.

- 400-lb weight capacity - evenly distributed.
- Fold-down back makes transport and storage easy.
- Carry straps on the seat allow for ease of lifting and folding.
- Black padded nylon upholstery is flame retardant.
- 3-Year limited warranty on side frames and crossbars.
- Meets Medicare code E1039.

[Accessories & Definitions, p.35](#)



cat.#	width	arm style	leg/foot style	price
BBWI-TA42	24"	fixed desk	swingaway foot	\$470.00

Seat			Back	Overall				Wt.
24"	18"	20"	18"	40"	39 1/4"	30 1/4"	12"	31#



Anti-Theft Wheelchair

Non-folding wheelchair with fixed post prevents theft.

- 500-lb weight capacity - evenly distributed.
- Reinforced frame at all load-bearing points.
- Industry compatible "Tool Free" adjustable front rigging.
- Black vinyl upholstery with chart pocket on the back.
- 5-Year limited warranty on side frames and crossbars.
- Meets Medicare code K0007.

cat.#	width	arm style	leg/foot style	price
BBWI-AT20	20"	fixed desk	elevating leg	\$575.00
BBWI-AT22	22"	fixed desk	elevating leg	\$585.00
BBWI-AT24	24"	fixed desk	elevating leg	\$600.00

Seat			Back	Overall			Wt.
20"	18"	20"	16 1/2"	34"	36"	28 1/2"	60#
22"	18"	20"	16 1/2"	34"	36"	28 1/2"	60#
24"	18"	20"	16 1/2"	34"	36"	28 1/2"	60#

Wheelchair Accessories

Fully adjustable to fit most standard wheelchairs.

O₂ & IV Holder

#BBWI-IO \$155.00

- Ht. adjustable pole.
- Chrome finish.
- 3-month warranty.



(O₂ cylinder not included)

1-Hook IV Holder

#BBWI-IV \$90.00

- Ht. adjustable pole.
- Chrome finish.
- 3-month warranty.



Oxygen Carrier

#BBWI-O2 \$45.00

- Holds D or E cylinders.
- Chrome finish.
- 3-month warranty.



Definitions



Desk Arm



Full Arm



Elevating Legrest



Swingaway Footrest

Motorized Multi-Purpose Stretcher-Chair

- Fully electric movement for optimal patient positioning.
- Quick-change battery pack (spare included) with hand-held controls.
- Electrically operated dual column base provides excellent stability.
- Radiolucent back allows x-ray, C-Arm, and fluoroscopy.
- Easy stretcher-to-chair-to-exam table conversion.
- Memory foam cushion for maximum patient comfort.
- Brake and steer caster system for easy maneuvering.
- Height range: 24" to 32".
- Backrest adjustment: 0° to 90°.
- Trendelenburg adjustment: 0° to 5°.
- Weight capacity: 500 lbs.



#CMT-MPI
(Call for Price)



Extremely Versatile!

There are dozens of options available to make this the perfect chair for your needs. Call for more information.

O₂ Holder

#CMT-O2 (Call for Price)

- Accommodates sizes "D" and "E" cylinders.
- Powder-coated steel.
- Fits all chairs.

IV Pole

#CMT-IV (Call for Price)

- Ht. adjustable pole.
- Stainless Steel.
- Fits all chairs.



Motorized Video Swallow Study Imaging Chair

- Fully electric movement includes 90° rotation.
- Available short wheel base for R/F towers with steel plates on the floor.
- Quick-change battery pack (spare included) with hand-held controls.
- Electrically operated dual column base provides excellent stability.
- Radiolucent back allows x-ray, C-Arm, and fluoroscopy.
- Easy stretcher-to-chair-to-exam table conversion.
- Memory foam cushion for maximum patient comfort.
- Brake and steer caster system for easy maneuvering.
- Height range: 24" to 32".
- Backrest adjustment: 0° to 90°.
- Trendelenburg adjustment: 0° to 5°.
- Weight capacity: 350 lbs.

90° rotation permits Lateral and AP imaging.



#CMT-VCP
(Call for Price)

Includes the CMT-VRB PLUS back extension, IV pole, O2 holder, and head/torso/leg belts.

#CMT-VRB (standard wheel base)
#CMT-VSB (short wheel base)
(Call for Price)



Child Seat Adapters

Contoured foam is soft, seamless, and durable.

SMALL BODY	MEDIUM BODY	LARGE BODY
30"-36"	36"-48"	48"-60"
20-40 lbs.	40-60 lbs.	48-80lbs.



Mobile Holder for CR/DR/Film Image Receptors Standard Tilt & Rotate

- Standard Tilt & Rotate (complete mobile unit)
#MCH-33C
\$1150.00
- Standard arm length provides maximum stability.
 - Fully articulating holder.

Easy to Clean for the "OR" Setting!



NEW!
Bilateral clamp safely secures receptors

Solid Stability of Sliding Holder on Post!

ALL MOBILE UNITS INCLUDE:

- Vertical range from bottom of image receptor: floor-to-54".
- *Posi-Lock* height adjustable arm with spring-loaded pin.
- Features 60" chromed steel post.
- 24" H-Base with locking casters.
- Broad base prevents tipping.
- Platinum baked enamel finish.
- Ships in two cartons: 1@15#, 1@45#.

H-Style Base Provides Greater Stability and Movement!



Mobile Holder for CR/Film Image Receptors Extension Arm Tilt & Rotate (not for DR)

Extension Arm Tilt & Rotate
(complete mobile unit)
#MCH-37C
\$1195.00

- Extends image receptors 11" to 23" from post.
- Heavy DR receptors may pose a tipping risk.



NEW!
Bilateral clamp
safely secures
receptors

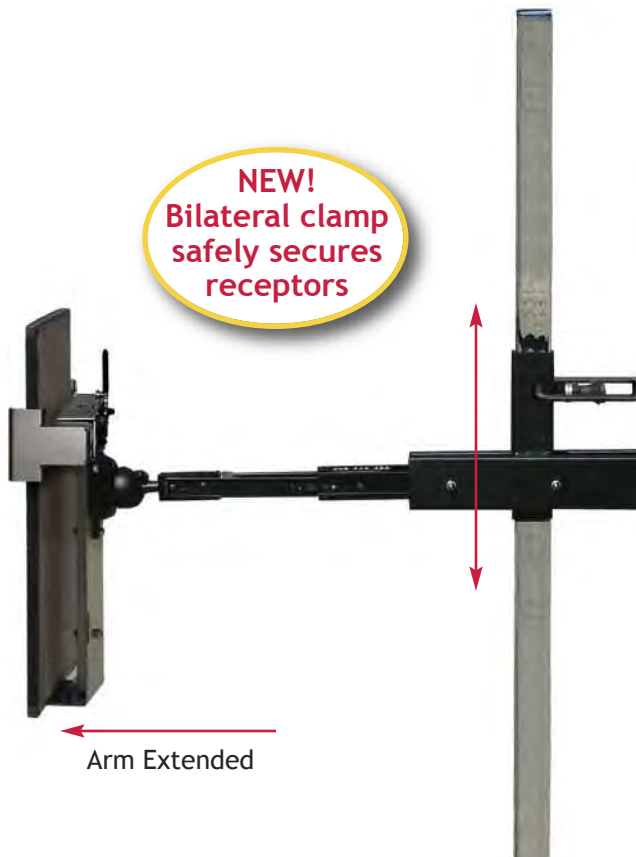

Arm Extended



Arm In and Locked

**1 1/2" Deep
Channel Accepts
Grids and Caps**

Tilt & Rotate Models: Range of Motion



- Straight Vertical
- Incline Forward
- Incline Backward
- Rotate or Oblique Tilt
- Face Up
- Face Down
- Anywhere in Between

Posi-Lock Handle: Fast and Secure



- (1) Pull the Pin
- (2) Slide the Holder
- (3) Release to Lock

Mobile Holder for Tall Format Image Receptors Non-Tilt & Rotate

Tall Format Lateral
(complete mobile unit)
#MCH-39C
\$1195.00

- Holds 14" x 36" or 51" image receptors.
- Fixed position only (non-articulating).

Perfect for Spine and Long Leg Studies!

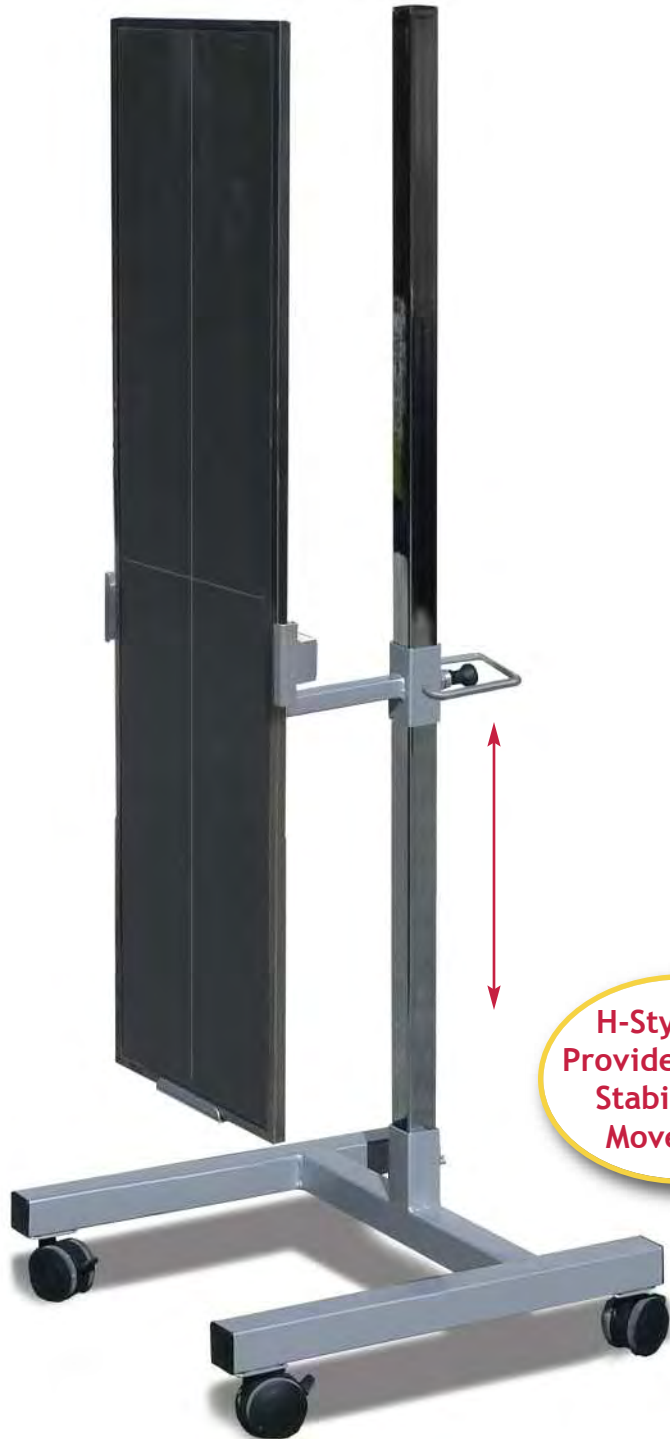

H-Style Base Provides Greater Stability and Movement!



ALL MOBILE UNITS INCLUDE:

- Vertical range from bottom of image receptor: floor-to-54".
- *Posi-Lock* height adjustable arm with spring-loaded pin.
- Features 60" chromed steel post.
- 24" H-Base with locking casters.
- Broad base prevents tipping.
- Platinum baked enamel finish.
- Ships in two cartons: 1@15#, 1@45#.

Mobile Holder for Heavy DR/CR Image Receptors Non-Tilt & Rotate

DR/CR Lateral
(complete mobile unit)
#MCH-40C
\$1150.00

- Holds up to 20 1/2" DR/CR image receptors.
- Maximum weight capacity: 22-lbs.
- Fixed position only (non-articulating).

NEW!
Bilateral clamp
safely secures
receptors



**Solid
Stability of
Sliding Holder
on Post!**



Tabletop Lateral Cassette/CR-Plate/DR-Plate Holders



24" Variable Height
CR-Plate/Cassette Holder
#35LCH
\$220.00



- Accepts grids and caps (channel is 1 1/4" d).
- Upper and lower channels slide on 24" post.
- Holds plates/cass. for up to 14" x 17" image sizes.
- Base plate slides under patient or pad.
- 35LCH upper channel includes a R & L marker.
- 40LDH features an upper channel that fits into handle and an extra large base for stability.
- Upper and lower channels are lined with rubber.
- Shipping weight: 35LCH @ 7 lbs / 40LDH @ 9 lbs.

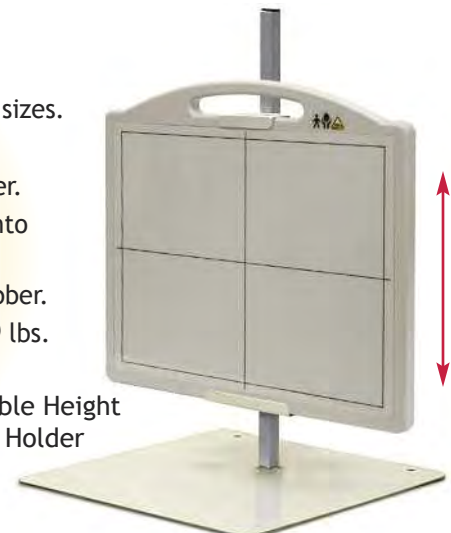

24" Variable Height
DR-Plate Holder
#40LDH
\$250.00



Lateral Weight Bearing Platform

- Allows for weight bearing imaging of the knees, ankles, and feet.
- Three receptor slots on the top platform and two slots on the bottom platform.
- Platforms are HD crosslink closed cell foam for comfort and support.
- 52" high safety rail provides for patient stability.
- 350-lb. weight capacity.
- Platform heights: 8 1/2" and 14 1/4".
- All steel frame with 30"l x 20"w base.
- Shipping weight: 55 lbs.

#WMP-12
\$1495.00



AP Weight Bearing Receptor Protectors

- Provides supportive platform when patient is required to stand on the receptor.
- Accommodates DR, CR, and analog panels.
- Supports patients up to 800-lbs.
- Frame is resilient aluminum with a clear polycarbonate support surface.
- Includes an easy-lift handle.



cat.#	receptor size	receptor style	price
WBC-1012W	10 x 12	cassette or wireless panel	\$630.00
WBC-1417W	14 x 17	cassette or wireless panel	\$895.00
WBC-1417T	14 x 17	tethered DR panel	\$935.00
WBC-1717T	17 x 17	tethered DR panel	\$1230.00

CR/DR/Film Receptor Covers

- Disposable; prevents cross-contamination.
- Keeps receptors clean and dry from exposure to bodily fluids, solutions, plaster, etc.
- Specifically designed to fit your imaging receptors.
- Non-sterile.
- Latex-Free!
- 2 mil polyethylene is transparent to x-ray.
- Can also be used to cover positioning sponges.
- Available in Standard Overlock and Ziplock™ closures.



Ships Next Business Day!

No Image Compromise!



Protect Your Investment!

Standard Flip-Lip Closure

- Allows safe handling and positioning of:
CR-Receptors, Cassettes, and DR-Receptors.
- ***Fits 23" x 25" DR-Receptors with Grids!**

cat.#	fits receptor size	quantity	price
CCS-08	8" x 10"	1 box of 100	\$59.00
CCS-10	8" x 10"	1 case of 500	\$268.00
CCM-10	10" x 12"	1 box of 100	\$59.00
CCM-12	10" x 12"	1 case of 500	\$268.00
CCL-14	14" x 17"	1 box of 100	\$59.00
CCL-17	14" x 17"	1 case of 500	\$268.00
CCC-DR	17"-20" x 17"-20"	1 box of 100	\$59.00
CCD-DR	17"-20" x 17"-20"	1 case of 500	\$268.00
CCXL-24*	23" x 25"	1 box of 100	\$59.00
CCXL-26*	23" x 25"	1 case of 500	\$268.00



Ziplock™ Closure

- Disposable bag securely seals in image receptors.
- Provides Maximum Protection from cross contamination.
- ***Fits 23" x 25" DR-Receptors with Grids!**

cat.#	fits receptor size	quantity	price
CCZ-14	14" x 17"	1 box of 100	\$59.00
CCZ-17	14" x 17"	1 case of 500	\$268.00
CCXZ-24*	23" x 25"	1 box of 100	\$59.00
CCXZ-26*	23" x 25"	1 case of 500	\$268.00



Compact Dispenser Box

Mobile Imaging Caddy

- Keep everything at your fingertips for mobile imaging.
- Conveniently hangs from mobile imager mast.
- Large pouch for Receptor Covers.
- Medium pouch for accessories.
- Two small pouches for markers, pens, and other small items.
- Heavy gauge, reinforced vinyl with clear outer pockets.



#PMA-C4
\$95.00



Other accessories
are not included.

Standard Wall Bins

- Non-shielded steel storage solutions.
- Will hold receptor plates, film jackets, and caddies.
- Opening is 22" w x 5" d x 14" h.



Standard Version
with polycarbonate
see-thru front.

#80AC
\$299.00



HIPAA Version
with solid steel
no-see front.

#80HP
\$299.00

Chart, Folder or Film Holder

- Steel backboard and base (open sides).
- Includes a convenient message clip.
- Rubber mat in base to keep folders from sliding.
- Used for charts, folders, caddies, film, etc.



Standard Version
with polycarbonate
see-thru front.

#89AC
\$111.00/ea.

- Color: Twilight.
- 14" w x 3" d x 12" h.
- Shipping: 8 lbs.



HIPAA Version
with solid steel
no-see front.

#89HP
\$116.00



Radiation Badge Storage Boards

- Provides a central location for all badge related activity.
- Exposure record display area and note clip.
- Accommodates different styles and sizes of badges.
- Ring board is also available for Nuclear Medicine and PET.



NARROW BADGES less than 1" wide



#FB-10N



#FB-20N



#FB-40N

cat.#	style	badges	board size	price
FB-10N	narrow	10	12" x 5"	\$79.00
FB-20N	narrow	20	12" x 9 1/4"	\$87.00
FB-40N	narrow	40	12" x 18"	\$135.00
FB-10W	square/hex	10	12" x 9 1/4"	\$105.00
FB-20W	square/hex	20	12" x 18"	\$135.00
FB-40W*	square/hex	40	12" x 18"	\$199.00
FB-10R	ring(nuc.med.)	10	12" x 5"	\$76.00



*(The FB-40W comes as two boards, each holding 20 badges.)

SQUARE, HEX, WIDE, OBLONG BADGES 1" to 2" wide



#FB-10W

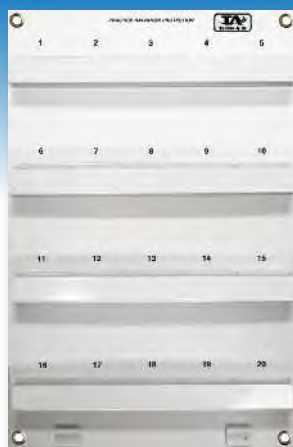

#FB-20W



#FB-40W

RING BADGES

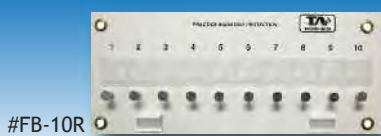

#FB-10R

Merrill's Pocket Guide to Radiography, 12th Edition

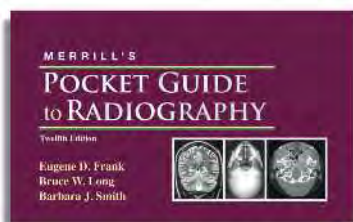

- Quick reference, soft cover spiral.
- Ideal for the clinical setting.
- Step-by-step illustrations for positioning 200 of the most common projections.
- Unique digital radiography reference radiographs.
- Handy technique chart for every projection, with manual and AEC techniques.
- 372 pages, 4 3/8" x 7 1/4", ships @ 1 lb.

#BK-MPGR \$59.00

Standard Step Stools

*Most Popular
Best Selling
Stool!*

- All steel **350-lb.** capacity.
- Skid resistant black mat.
- 9" high stool with 11" x 13³/₄" top; 34" tall with handrail.
- Handrail is 7/8" dia. chrome-plated tubular steel.
- Easy assembly.
- Shipping weight: stool 8 lbs.; handrail 4 lbs.



#BSS-60
\$67.00



#BSH-65
\$99.00

Heavy Duty Step Stools

- Bariatric **600-lb.** capacity.
- Steps have a skid resistant black mat surface.
- Height:
Single Step: 8³/₄" high step; 34¹/₂" with handrail.
Double Step: 8" & 16" high steps; 43" with handrail.
- Handrail is 1" dia. chrome-plated 16g steel.
- Shipping weight:
Single Step: stool 8 lbs.; handrail 6 lbs.
Double Step: stool 20 lbs.; handrail 5 lbs.



#BBS-61
\$173.00



#BBD-63
\$348.00



#BBS-62
\$129.00



#BBD-64
\$279.00

Bariatric Step Stools

- Bariatric **1000-lb.** capacity.
- Step has anti-slip gripper strips.
- Flared base legs to prevent tipping.
- Step Only: 19" long x 15" wide x 8" high.
- Handrail model height is 36".
- Shipping weight: stool 11 lbs.; handrail 8 lbs.



#BBH-69
\$395.00



#BBH-68
\$225.00

#BRF-45
\$17.00



- Set of four (4) rubber tips for standard and bariatric step stools.
- Also fits BAS-30 stool.

Step Platforms

- Large area platforms offer superior patient stability.
- Laminated high pressure hardboard.
- Step has non-slip tread.

#BHW-01
\$265.00
20"w x 16"d x 8"h
300-lb capacity



Oak Laminate

#BHW-02
\$265.00
20"w x 16"d x 8"h
300-lb capacity



Gray Laminate

#BHW-03
\$715.00
24"w x 28"d x 4"-8"h
500-lb capacity



Oak Laminate

IV Stands

- 1" and 7/8" telescoping, chromed steel tubes.
- 22" diameter base.
- Coated, bar steel base with scuff guard tips resists corrosives.
- Adjustable height range.
- Two or four rams-horn style IV hooks.
- Available in either Twist Lock or Knob Lock.



Twist Lock

#BIV-70
\$99.00
2-Hook
Ht: 46"-83"
Ships @ 17 lbs.



Knob Lock

#BIV-72
\$149.00
2-Hook
Ht: 52"-91"
Ships @ 18 lbs.



#BIV-75
\$186.00
4-Hook
Ht: 52"-91"
Ships @ 19 lbs.

Instrument Stands

- Provides ready access to equipment or instruments.
- Leg posts are 1" chrome plated steel.
- Steel, easy-slide extension posts.
- Stainless steel tray is 12" x 19" x 3/4" deep.



Tableside

#BMS-80
\$235.00
Ht: 34"-54"
Ships @ 19 lbs.



Mobile

#BMS-95
\$225.00
Ht: 31"-50"
Ships @ 17 lbs.
in two boxes

Hampers

Tilt-Lid Hampers

- Lidded hampers provide sanitary environment for soiled linens.
- Durable, epoxy coated steel lid.
- Pedal activated lid with lid prop.
- Chrome plated steel frame.
- 3" rubber wheel casters.



#BHS-10 (WHITE LID)
#BHS-20 (RED LID)
\$235.00
Ships @ 27 lbs.



Folding Hamper

- Adjustable for 18", 22", or 25" bags.
- Chrome plated steel frame.
- 3" rubber wheel casters.

#BHF-10
\$190.00
Ships @ 18 lbs.

Hamper Bags

- Drawstring hamper bags for all models.
- #BAG-35 (35-gallon capacity) \$45.00
#BAG-45 (45-gallon capacity) \$55.00



Standard Exam Lamp

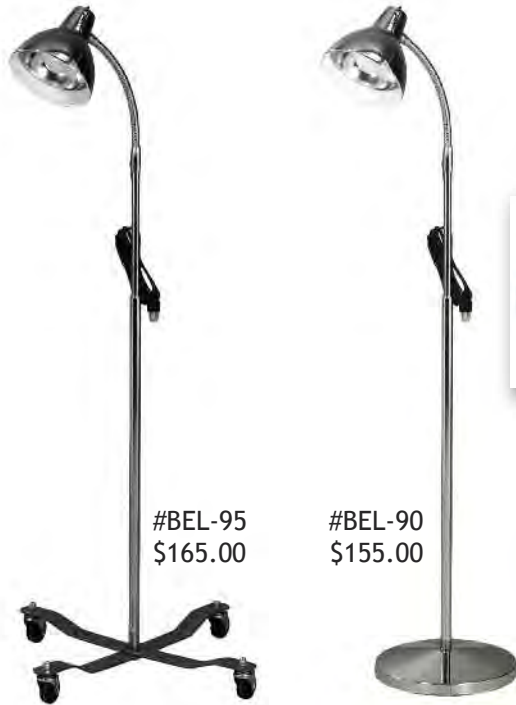

#BEL-95
\$165.00

#BEL-90
\$155.00



Inner shade keeps outer shade cool

- Flexible gooseneck arm with 360° adjustable steel shade.
- Chrome steel stand has adjustable height range: 50" to 74".
- Uses one 60-watt incandescent bulb (not included).
- Weighted stationery base or 23" diameter mobile base.
- Weight: 7 lbs.

Halogen Exam Lamp



#BEH-93
\$412.00

#BEH-91
\$335.00



Heat sink technology keeps light housing cool

- Flexible gooseneck arm with 540° adjustable head.
- Beige enamel coated steel stand is adjustable to 65 1/2".
- Uses one high intensity 35-watt halogen lamp (incl.).
- 1500 Footcandles @ 24"; 3000° Kelvin.
- Weighted stationery base or 18" diameter mobile base.

High Intensity LED Exam Lamp



Low temperature, high definition light source for better detail.

- Six LEDs use 79% less energy than halogen.
- 27900 Footcandles @ 12"; 4200° Kelvin.
- Counter-balanced arm for optimal reach.
- Removable diffusion filter widens focus from 10° to a full 60°.
- 25" diameter weighted mobile base.

#BEL-70
\$1375.00

Featherlight Halogen Lamp

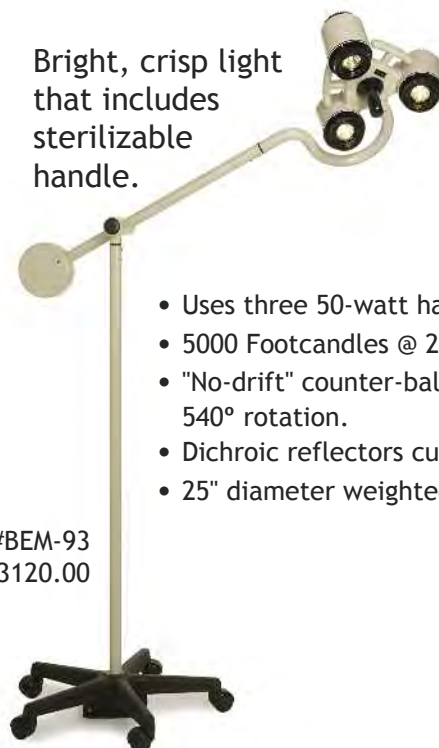

Bright, crisp light that includes sterilizable handle.

- Uses three 50-watt halogen lamps.
- 5000 Footcandles @ 24"; 4000° Kelvin.
- "No-drift" counter-balanced arm provides 540° rotation.
- Dichroic reflectors cut 80% of beam heat.
- 25" diameter weighted mobile base.

#BEM-93
\$3120.00



**Spin-Lift
Adjustable
Stool
5-Leg**

#BAS-40
\$249.00



- Solid steel, machined thread screw adjusts height by rotation of the stool cushion.
- Adjustable height: 17¹/₄" to 21³/₄".
- 16" x 4" thick seat cushion.
- 5-leg, die cast aluminum base.
- 23" base provides excellent stability.
- Weight: 21 lbs.; Ships @ 30 lbs.

**Spin-Lift
Adjustable
Stool
4-Leg**

#BAS-30
\$199.00



- Solid steel, machined screw adjusts height by rotation of the stool cushion.
- Adjustable height: 18" to 24¹/₂".
- 14¹/₂" x 4" thick seat cushion.
- 4-leg chrome steel base with footring.
- Weight: 20 lbs.; Ships @ 30 lbs.

**Pneumatic
Lift
Stool**

#BPS-20
\$299.00



- Pneumatic gas cylinder easily adjusts height with convenient under-cushion ring.
- Adjustable height: 17¹/₂" to 22¹/₂".
- 16" x 4" thick seat cushion.
- 5-leg, die cast aluminum base.
- 23" base provides excellent stability.
- Weight: 20 lbs.; Ships @ 30 lbs.

**Pneumatic
Lift
Stool
with
Backrest**

#BPS-22
\$389.00



(BPS-20 with adjustable backrest and D-ring height lever)

Silk Screened Signs

- All signs are constructed of 1/8" thick Trovicel™.
- Double-faced tape is attached to the back of each sign for mounting.
- Large Signs are 8" x 10".
- Small Signs are 4" x 10".
- The large MRI "Danger" Signs are 12" x 18".



#NFD-22B \$19.00



#NFD-22R \$19.00

English

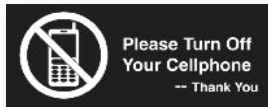

#NCP-24B \$13.00



#NCP-24R \$13.00



#CXR-13EB \$13.00



#CXR-13ER \$13.00



#XRR-19B \$13.00



#XRR-19R \$13.00



#CDK-11B \$13.00



#CDK-11R \$13.00

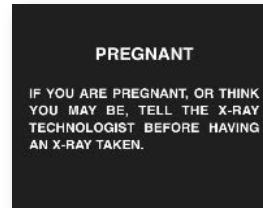

#PS-04EB \$19.00

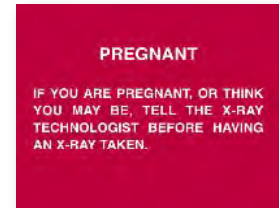

#PS-04ER \$19.00

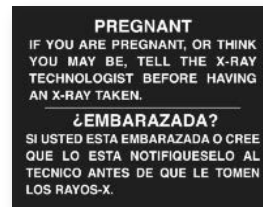

#PS-08B \$19.00

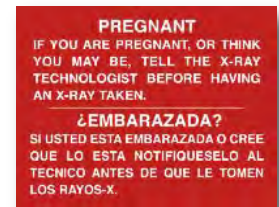

#PS-08R \$19.00

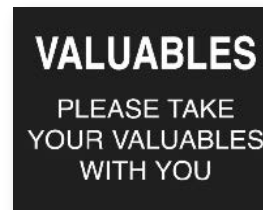

#VS-10EB \$19.00

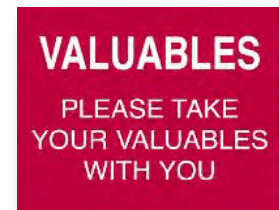

#VS-10ER \$19.00

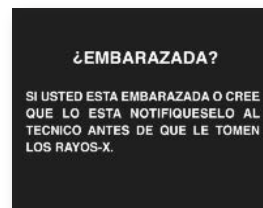

#PS-04SB \$19.00

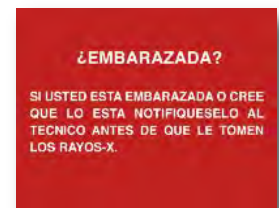

#PS-04SR \$19.00

Spanish



#CXR-13SB \$13.00



#CXR-13SR \$13.00



#CDR-12B \$13.00



#CDR-12R \$13.00

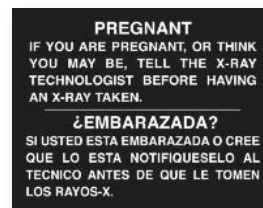

#PS-08B \$19.00

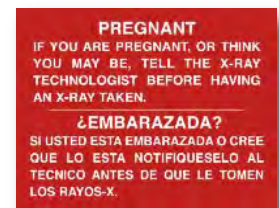

#PS-08R \$19.00

- Signs give critical information to patients & technologists.
- Many states adopt certain signs as law.
- Check your local laws or program requirements.

- Enhances safety with a front line written warning.
- Part of a good quality assurance program.
- Custom signs available for quote (best price with multiples).



Caution



#CRA-15 \$19.00



#CRA-17 \$13.00



#CBH-14 \$13.00

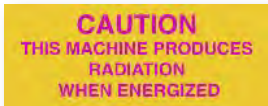

#CRE-18 \$13.00

MRI



#CMF-01 \$19.00

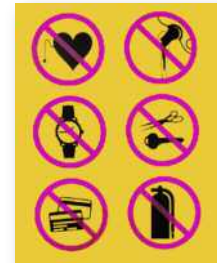

#CMM-06 \$27.00



#MBN-13E \$50.00



#MBN-14S \$50.00



#MBN-15E \$30.00



#MBN-16S \$30.00

- Large Signs are 8" x 10".
- Small Signs are 4" x 10".
- The large MRI "Danger" signs are 12" x 18".

Custom Engraved Signs

- Engraved 1/16" thick Rowmark™.
- Stock colors: White letters in Red plate, White letters in Black plate, Red letters in Yellow plate.
- Double-faced tape attached to the back for mounting.
- Letters and numbers only; no symbols.
- Other unusual sizes and styles available for quote.

Example: 5" x 9" = 45 sq. in.

#SI-48 @ \$32.00



Example Sign

size	cat.#	price
48 sq. inches or less	SI-48	\$32.00
over 48 sq. in. and up to 144 sq. in.	SI-144	\$38.00

Aquasonic® 100

industry standard
ultrasound transmission gel

- Recommended for all procedures where a viscous gel is required.
- Acoustically correct for the broad range of frequencies used.
- Aqueous formula will not stain clothing or damage transducers.
- Hypoallergenic, bacteriostatic, non-sensitizing, non-irritating.

cat.#	size per unit	units/box	price/box
USO-025	250ml bottle	12	\$41.00
USO-100	1 liter bottle	6	\$74.00
USO-500	5 liter jug w/ bottle	1	\$30.00
USO-048	20g sterile pouch	48	\$95.00



Aquasonic Clear®

same as Aquasonic® 100,
but with no fragrance or color

- Recommended for all procedures where a viscous gel is required.
- Acoustically correct for the broad range of frequencies used.
- Aqueous formula will not stain clothing or damage transducers.
- Hypoallergenic, bacteriostatic, non-sensitizing, non-irritating.

cat.#	size per unit	units/box	price/box
USC-025	250ml bottle	12	\$42.00
USC-100	1 liter bottle	6	\$76.00
USC-500	5 liter jug w/ bottle	1	\$31.00



Ultrasound Probe Covers

- Acoustically transparent, minimizing distortion during scanning.
- Available in Latex or Latex-Free and Sterile or Non-Sterile.
- A variety of style and sizes for many applications and specialties: Radiology, Vascular, Cardiology, Urology, Phlebology, Emergency Medicine, OB/GYN, etc.



cat.#	description	diameter x length	qty/box	price/box
	LATEX PROBE COVERS, NON-STERILE			
USP-LN01	condom size, bulk pack	1.25" x 8"	100	\$49.00
USP-LN03	condom size, individually wrapped	1.25" x 8"	100	\$69.00
USP-LN04	extra-long, bulk	1.18" x 11.8"	100	\$139.00
	LATEX-FREE PROBE COVERS, NON-STERILE			
USP-FN03	rolled, individually wrapped	1" x 9"	100	\$149.00
USP-FN04	extra long, individually wrapped	1" x 12"	100	\$149.00
	LATEX-FREE PROBE COVERS, STERILE			
USP-FS01	semi-rolled and tapered, bulk pack	1"d x 9"	50	\$249.00
USP-FS02	semi-rolled, wide abdominal	3.5"flat x 12"	25	\$159.00

Elemental Ultrasound Stool

- Sit in comfort during extended ultrasound procedures.
- Back height adjustment.
- Tilting backrest.
- Pivot backrest.
- Tilting seat.
- Warranty: 7-year limited.
- Seat: 19" w x 19" d.
- Back: 19" w x 17.5" h.
- seat height range: 23"-33"
- overall height: 42"-55"
- 20" chrome footring.
- ships @ 68# (actual wt. 46#)

FABRICS
PAGE 120

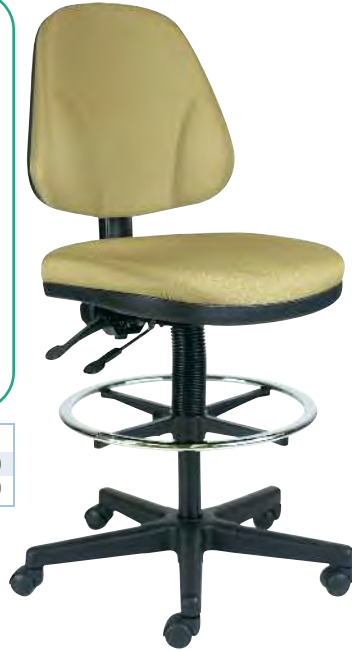

cat.#	choose fabric #	price
ZOES-MX03	Grade 1-3	375.00
ZOES-MX46	Grade 4-6	420.00

See p. 64 for
Ultrasound
positioning
sponges.



Hover Ultrasound Stool

#ZOWS-15 (Black ONLY)
\$260.00

Unique 20° forward tilt
offers support while
leaning toward patient.



- Ease lower back stress.
- Seat tilts forward 20°.
- Seat height: 22"-32"
- Overall ht:
28.5" w x 38.5" h.
- 7-year limited warranty.
- Ships @ 33#.

Ultrasound Gel Warmers

fits standard 250ml gel bottles

Steel Gel Warmers

- "Uni-Sleeve" heating element adjusts up to 122°F.
- Illuminated On/Off switch with hospital grade cord.
- Stainless Steel with white powder coat finish.
- 5"w/8"w/11"w x 6"d x 5"h.



cat.#	rating	capacity	price/box
UGW-U01	UL/CSA approved	1	\$175.00
UGW-U02	UL/CSA approved	2	\$235.00
UGW-U03	UL/CSA approved	3	\$265.00

Composite Gel Warmers



- Maintains constant temperature.
- Impact-resistant composite housing.
- Hospital grade power cord.
- **Three Bottle Unit ONLY:**
 - Illuminated On/Off switch.
 - Energy-saving lid.
 - **3-position thermostat (UGP-UL3):**
Low: 97°F / Medium: 102°F / High: 109°F.
 - **Digital display thermostat (UGP-ULD):**
1° increments from 97°F to 109°F.
- **Single bottle unit** is factory set at 104°F with a heat indicator lamp.



cat.#	rating	capacity	price/box
UGP-UL1	UL/CSA approved	1	\$215.00
UGP-UL3	UL/CSA approved	3	\$340.00
UGP-ULD	UL/CSA approved	3	\$380.00

MRI Furniture

- Each piece is non-magnetic and safe to use in the MRI environment.
- Some weights do not reflect OverSize UPS/FedEx Rate.

 = MR Conditional (no hazards up to 3-Tesla);  = MR Safe (no known hazards);  = MR Unsafe (danger/known hazard).

MRI Step Stool w/ Handrail

- Stainless steel construction.
- 500# weight capacity.
- Step: 16"w x 12"d x 8½"h.
- Handrail height: 41".
- "MRI Green" mat; rubber tips.
- Ships @ 13 lbs (+oversize) UPS/FedEx.



#MBS-65
\$355.00

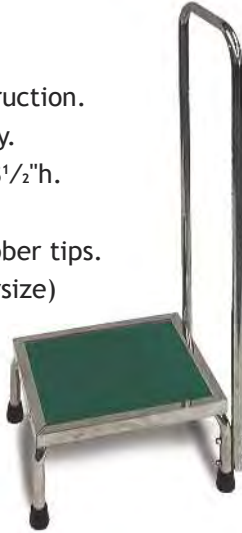

MRI Two-Step Platform Stool w/ Handrail

- Stainless steel.
- 400# weight capacity.
- Top Step: 36"w x 12"d x 16"h, Bottom Step: 36"w x 12"d x 8"h.
- Handrail height: 41".
- "MRI Green" mat; rubber tips.
- Ships @ 48 lbs, motor freight.



MRI Chairs & Stools

- Screw-post height adjustment.
- 4" padded seat
- Seat upholstered in "MRI Green."
- Ships via UPS/FedEx.



MRI IV Pole

- Extends from 48" to 92½".
- 24" diameter base.
- 2" swivel casters.
- Ships via UPS/FedEx:
Pole @ 3 lbs,
Base @ 7 lbs.



cat.#	description	price
MBI-70	2-hook iv pole	\$495.00
MBI-75	4-hook iv pole	\$520.00

cat.#	height range	features	base	ship wt.	price
CHAIRS					
MBC-30CC	17"-23"	chair only	casters	22	\$800.00
MBC-31CC	17"-23"	chair+back	casters	24	\$990.00
MBC-30CT	15"-21"	chair only	tips	22	\$730.00
MBC-31CT	15"-21"	chair+back	tips	24	\$880.00
STOOLS					
MBC-30SC	23"-29"	stool only	casters	22	\$800.00
MBC-31SC	23"-29"	stool+back	casters	24	\$990.00
MBC-30ST	21"-27"	stool only	tips	23	\$775.00
MBC-31ST	21"-27"	stool+back	tips	25	\$885.00

MRI Wheel Chairs

- 24" diameter wheels, 8" front casters.
- Burgundy upholstery.
- Smooth ride, rust-proof hand rims.
- Retractable wheel locks.
- Quick release seat belt.
- Sling style seat (bariatric: solid padded seat).
- Ships via UPS/FedEx (bariatric: motor freight).

cat.#	seat width	overall	weight cap.	ship wt.	price
MBW-18	18"	26"	250#	53	\$2685.00
MBW-20	20"	28"	250#	55	\$2990.00
MBW-22	22"	30"	350#	62	\$3600.00
MBW-24	24"	30"	350#	62	\$3985.00
MBW-24B	24"	35"	550# bari.	67 & 13	\$5370.00
MBW-26B	26"	35"	550# bari.	67 & 13	\$5240.00
MBW-10	I.V.Pole & O ₂ E-tank mount			7	\$340.00



Standard MRI Wheel Chairs



Bariatric Wheel Chairs



"MR" is on the back of every chair.



MRI PVC Transport Gurney

350# CAPACITY	600# CAPACITY
#MBG-3PV	#MBG-6PV
\$1780.00	\$2040.00

- Economic PVC construction.
- Three weight capacities.
- Features flip-down side rails.
- Three position backrest.
- 79"l x 28"w x 33 1/2".
- Four locking casters, two or four stationary.
- Either ships @ 150 lbs, motor freight.



MRI Transport Gurney

#MBG-6SS (HEAVY DUTY)
\$6615.00

- 600# weight capacity.
- Stainless steel construction.
- Features flip-down side rails.
- Backrest adjusts from 0° to 75°.
- Non-marring bumper pads.
- 70"l x 30"w x 39"h.
- Four locking casters.
- Ships @ 300 lbs, motor freight.

Options for MBG-6SS:

IV Pole Attachment
#MBG-IV
\$315.00

O₂ Tank Holder
#MBG-O2
\$275.00



MRI POSITIONING SPONGES

MRI COMFORT PILLOW

- Gently elevates head during MRI & CT exams.
- Includes handhold straps.
- 16 x 25 x 8 1/4.
- Nylon covering.

#MPP-16
\$240.00



Additional MRI positioners and table pads can be found on page 69.

LEG REST WITH KNEE CUTOUTS

- Provides leg and knee support while maintaining hip flexion.
- Reduces back stress.
- 18 x 24 x 10.
- Cleanable coating.

#MCP-LK
\$515.00



ADJUSTABLE LEG POSITIONER

- Specifically designed for RADIUS table tops.
- Removable pads allow three different knee heights.
- Cleanable coating.

#MCP-AP
\$530.00



MRI Warning Signs

- Durable plastic silk-screened signs.
- Double-faced tape is on the back for mounting.
- Additional signs are available on pages 50 & 51.

cat.#	sign #	description	size	price
CMF-01	A	yellow, 1 symbol	8"x10"	\$19.00
CMM-06	B	yellow, 6 symbols	8"x10"	\$27.00
MBN-13E	C	restricted access (Eng)	12"x18"	\$53.00
MBN-14S	D	restricted access (Sp)	12"x18"	\$53.00



MRI Earplugs

- Economical protection.
- Latex-free.
- Use w/ headset or alone.
- Bulk packaged as 1000 pcs.

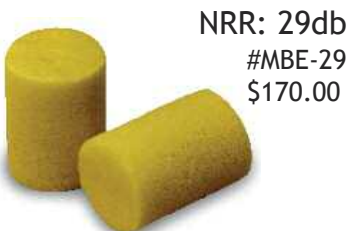

NRR: 29db
#MBE-29
\$170.00



NRR: 33db
#MBE-33
\$160.00

Metal Detector

#MBM-MD
\$325.00

- Save patients and staff from embarrassing and hazardous situations.
- Features large scan surface w/ sensitivity reduction switch.
- Ships @ 15 lbs, UPS/FedEx.

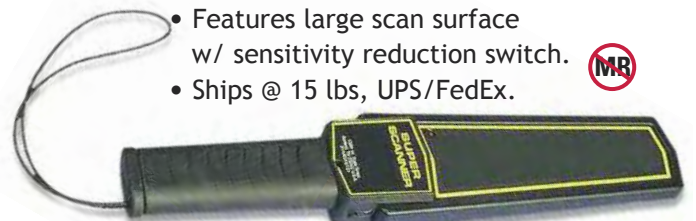

MRI Transfer Boards

- Allows safe and efficient transfer of patients for general imaging, MRI, and CT.
- Durable, semi-rigid, slick material makes positioning under the patient easy.
- Transfer boards are radiolucent can be used in the imaging field.
- Conveniently located 1 1/2" x 4 1/2" hand-holds allow optimal movement.
- Regular Boards are made of 3/16" thick HDPE (high density polyethylene).
- Regular board color is white.
- Transfer boards ship at OverSize rates.

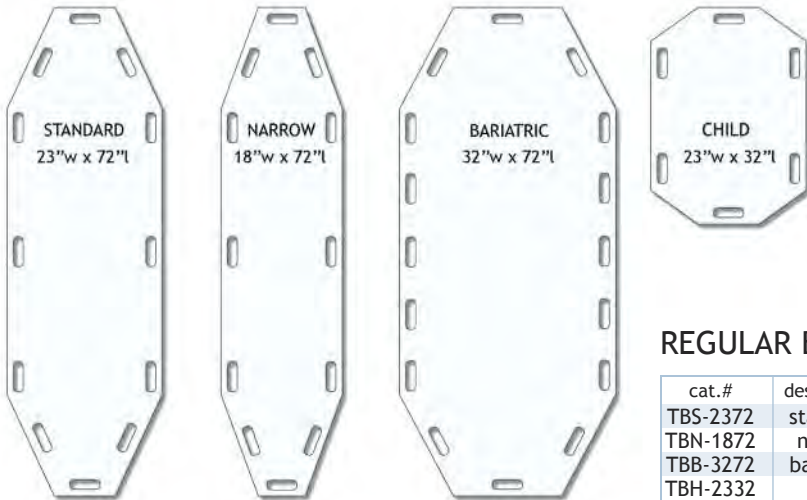

REGULAR BOARDS

cat.#	description	price
TBS-2372	standard	185.00
TBN-1872	narrow	165.00
TBB-3272	bariatric	235.00
TBH-2332	half	90.00

ANTI-STATIC BOARDS



cat.#	description	price
TBS-2372AS	standard	255.00
TBN-1872AS	narrow	245.00
TBB-3272AS	bariatric	575.00
TBH-2332AS	half-size	110.00

MRI Sandbags

- All sandbags are filled with MRI-Safe sand and are ready to use.
- Heat sealed inner sleeve prevents the leakage of sand.
- All seams are sewn and tear resistant.
- Color-coded outer cover is heavy gauge, reinforced vinyl.
- Every sandbag includes a reinforced webbing handle.



MRI Utility Carts

- Covered utility carts are MRI Conditional up to 3T.
- Manufactured with medical grade polymer plastic.
- Reinforced vinyl covers are flame resistant, mildew resistant, and antimicrobial.
- Front flap is secured with hook & loop.
- Includes heavy duty casters.
- Shipped unassembled.



#MUC-225
\$535.00 ea.

- Two 20"x30" shelves.
- Load: 75-lbs per shelf.
- 12" shelf clearance.
- Height: 37"



#MUC-245
\$730.00 ea.

- Two 20"x45" shelves.
- Load: 125-lbs per shelf.
- 16" shelf clearance.
- Height: 46"



#MUC-332
\$680.00 ea.

- Three 20"x32" shelves.
- Load: 100-lbs per shelf.
- 12" shelf clearance.
- Height: 51 1/2"



Choose the shape, size and style to meet your needs!

- Sponges are used to provide comfortable positioning of the patient or to support a particular focal area of the body.

- Coated sponges** are made of **Antimicrobial "Ultra Fresh."**

- Sponges are available in standard, coated and bariatric styles.



NON-COATED STANDARD GRAY SPONGE

Soft, open cell, polyurethane foam provides excellent support and comfort. This foam has minimal attenuation, is fire retardant, and has been the industry standard for decades.



COATED STANDARD SPONGE

This is the same standard gray sponge outlined above, but is coated with a medical-grade, durable and easy-to-clean vinyl surface that is resistant to blood, Betadine®, barium, alcohol, oils and other fluids. Attenuation is very low (*edges may show, depending on techniques using low kVp*). Ideal for sterile environments.



NON-COATED HIGH-DENSITY SPONGE (See Bariatric Section)

These large-sized blocks are specifically designed to provide extra firm support for bariatric and athletic patient positioning. Coated versions are also available.

WEDGE POSITIONING SPONGES

NON-COATED STANDARD GRAY SPONGE

COATED STANDARD SPONGE

(For COATED SPONGES ONLY: edges may appear on images.)

#UFBE
\$12.50/set

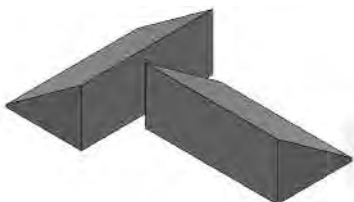

34° WEDGE (SET OF 2)
4 X 7 X 3

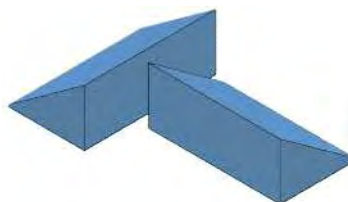

#UCBE
\$45.00/set

#UFBH
\$16.50/set

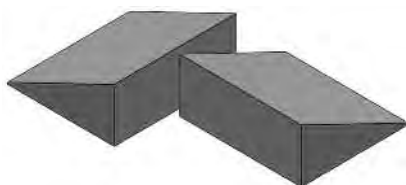

16° WEDGE (SET OF 2)
7 X 8 X 3.5

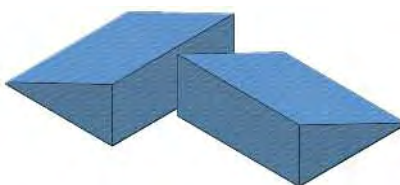

#UCBH
\$84.00/set

#UFB I
\$14.50/set

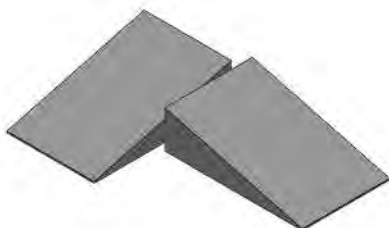

15° WEDGE (SET OF 2)
11 X 7 X 3



#UCB I
\$108.00/set

#UFB J
\$13.50/set



12° WEDGE (SET OF 2)
9.5 X 7.25 X 2.25

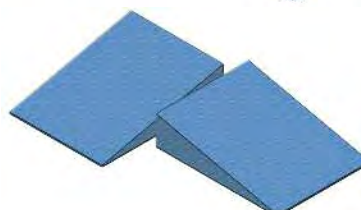

#UCB J
\$80.00/set

WEDGE POSITIONING SPONGES

NON-COATED STANDARD GRAY SPONGE

COATED STANDARD SPONGE

(For COATED SPONGES ONLY:
edges may appear on images.)

#UFEA
\$30.00

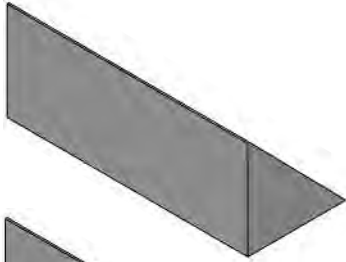

45° SPINAL WEDGE
9.5 X 24 X 9.5

#UCEA
\$120.00

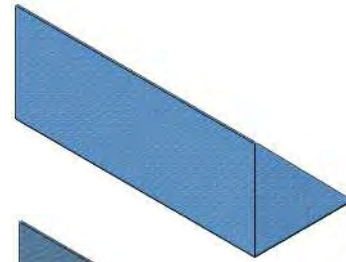

#UFEE
\$35.00

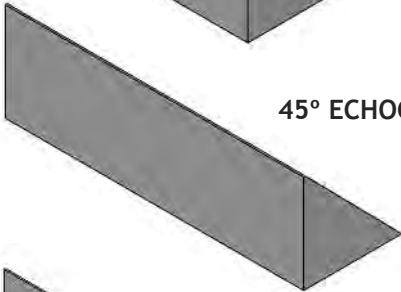

45° ECHOCARDIOGRAPHY WEDGE
9 X 30 X 9

#UCEE
\$128.00

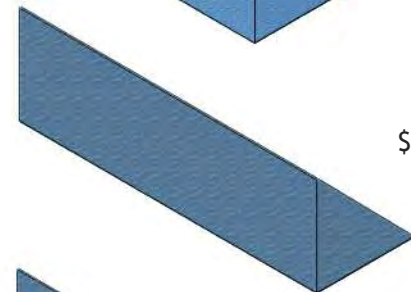

#UFBD
\$30.00

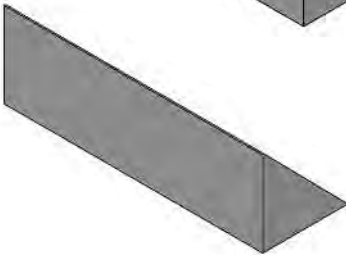

45° SPINAL WEDGE
7 X 21.5 X 7

#UCBD
\$106.00

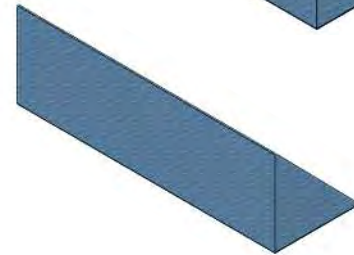

#UFBB
20.00



45° WEDGE
7 X 14 X 7

#UCBB
\$73.50

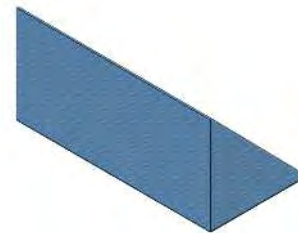

#UFBC
\$17.50



45° WEDGE
7 X 7 X 7

#UCBC
\$47.50



#UFBU
\$27.50



30°-60°-90° MULTI-ANGLE
10 X 24 X 6

#UCBU
\$195.00

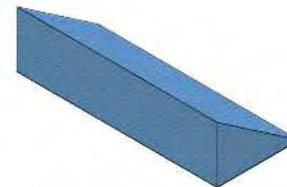

#UFBF
\$18.50



27° WEDGE
10 X 10 X 6

#UCBF
\$63.00

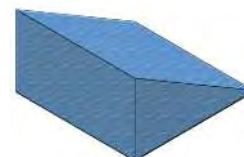

#UFBG
\$11.50



21° WEDGE
10 X 10 X 4.63

#UCBG
\$67.50



RECTANGLE POSITIONING SPONGES

NON-COATED STANDARD GRAY SPONGE

COATED STANDARD SPONGE

(For COATED SPONGES ONLY:
edges may appear on images.)

#UFBL
\$11.50



3" RECTANGLE
7.5 X 10 X 3



#UCBL
\$42.50

#UFBN
\$31.50



3" RECTANGLE
14 X 18 X 3



#UCBN
\$156.00

#UFBO
\$22.50



4" SQUARE SPONGE
10 X 10 X 4



#UCBO
\$70.50

#UFBY
\$52.00



4" SQUARE SPONGE
18 X 24 X 4



#UCBY
\$198.00

BODY/TORSO POSITIONING SPONGES

NON-COATED STANDARD GRAY SPONGE

COATED STANDARD SPONGE

(For COATED SPONGES ONLY:
edges may appear on images.)

#UFAW
\$149.00

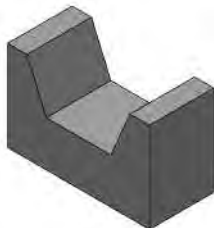

ADULT MYELOGRAM BLOCK
10 X 22 X 14

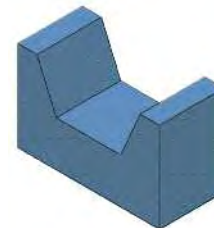

#UCAW
\$287.00

#UFAX
\$61.00

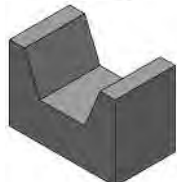

CHILD MYELOGRAM BLOCK
8 X 14 X 10

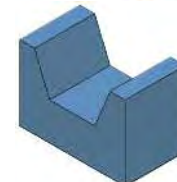

#UCAX
\$120.00

#UFAY
\$69.00



ANGULAR BOLSTER
12.5 X 16 X 7.25



#UCAY
\$149.00

HEAD/NECK POSITIONING SPONGES

NON-COATED STANDARD GRAY SPONGE

COATED STANDARD SPONGE

(For COATED SPONGES ONLY:
edges may appear on images.)

#UFAK
\$11.50



CIRCULAR HEAD BLOCK
7 X 1.5



#UCAK
\$26.00

#UFAL
\$35.00

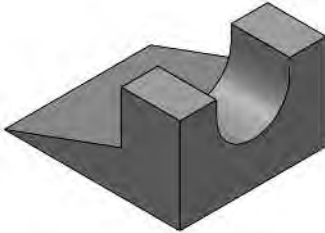

HEAD & NECK SUPPORT
12 X 10 X 6.5

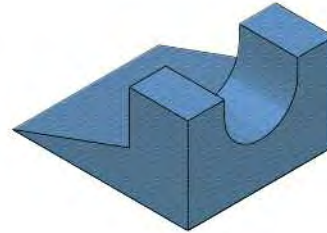

#UCAL
\$77.00

#UFAM
\$47.50

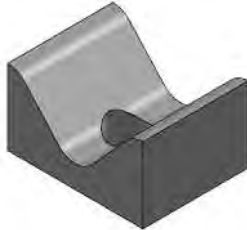

AP/PA ADULT HEAD HOLDER
10 X 11 X 6.75

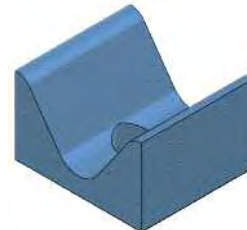

#UCAM
\$126.00

#UFAN
\$34.00



AP/PA CHILD HEAD HOLDER
7 X 9 X 5

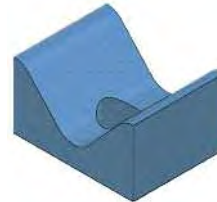

#UCAN
\$77.00

#UFAP
\$77.50

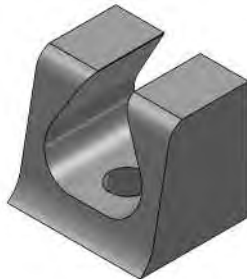

ADULT HEAD IMMOBILIZER
9 X 11 X 9.75

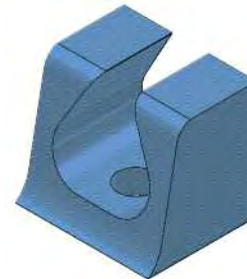

#UCAP
\$152.00

#UFAQ
\$49.00



CHILD HEAD IMMOBILIZER
6 X 9 X 7



#UCAQ
\$84.00

#UFAR
\$20.00



CERVICAL HEAD REST
6 X 12 X 4.5



#UCAR
\$69.00

EXTREMITY POSITIONING SPONGES

NON-COATED
STANDARD GRAY SPONGE

COATED
STANDARD SPONGE

(For COATED SPONGES ONLY:
edges may appear on images.)

#UFAA
\$11.50

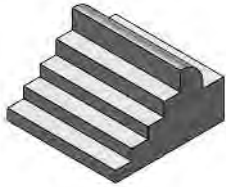

ADULT OBLIQUE
FINGER BLOCK

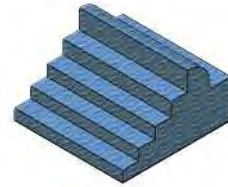

#UCAA
\$29.00

#UFAB
\$24.00

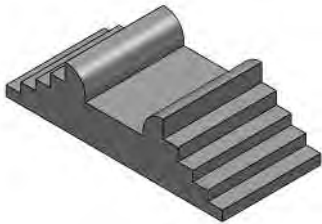

BILATERAL ADULT
OBLIQUE FINGER BLOCK

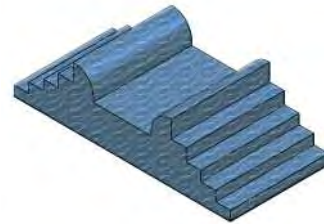

#UCAB
\$50.00

#UFAC
\$10.00

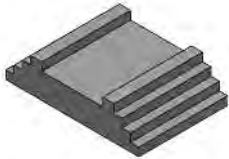

BILATERAL PEDIATRIC
OBLIQUE FINGER BLOCK

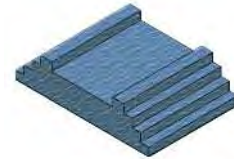

#UCAC
\$22.50

#UFAD
\$19.00

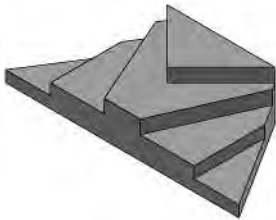

ADULT LATERAL
FINGER BLOCK

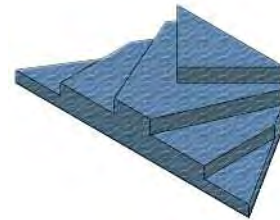

#UCAD
\$66.50

#UFAE
\$16.50

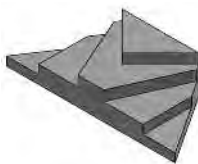

PEDIATRIC LATERAL
FINGER BLOCK

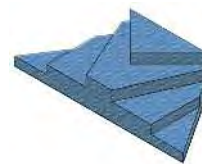

#UCAE
\$34.00

#UFAH
\$40.00

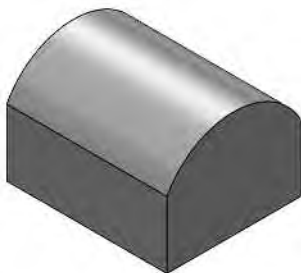

KNEE ARTHROGRAM BLOCK
10 X 12 X 8



#UCAH
\$117.00

#UFAJ
\$97.50



CT KNEE WEDGE SUPPORT
22 X 13.5 X 7



#UCAJ
\$283.00

EXTREMITY POSITIONING SPONGES

**NON-COATED
STANDARD GRAY SPONGE**

**COATED
STANDARD SPONGE**

*(For COATED SPONGES ONLY:
edges may appear on images.)*

#UFAF
\$61.50

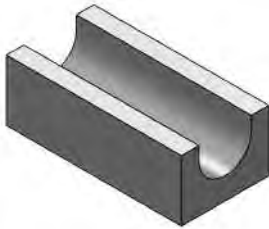

**LEG IMMOBILIZER
10 X 20 X 7**

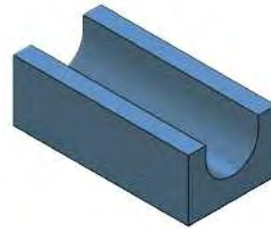

#UCAF
\$206.00

#UFAG
\$108.00

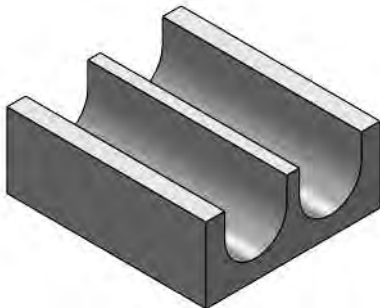

**BILATERAL LEG IMMOBILIZER
14 X 16 X 6**

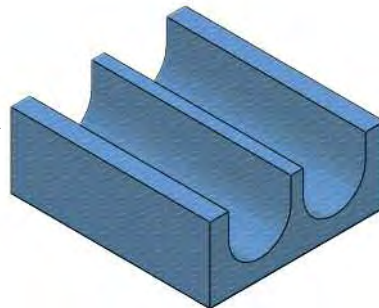

#UCAG
\$211.00

#UFCA
\$21.00



**SMALL EXTREMITY BLOCK
3 X 4 X 10**



#UCCA
\$49.00

#UFCB
\$35.00

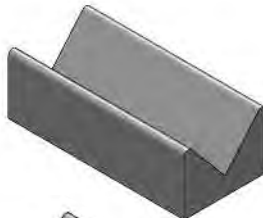

**MEDIUM EXTREMITY BLOCK
5 X 7 X 15**

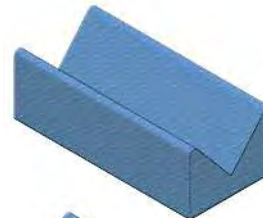

#UCCB
\$108.00

#UFCC
\$66.50

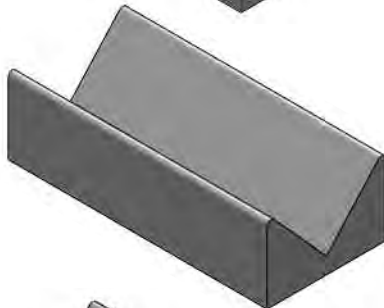

**LARGE EXTREMITY BLOCK
7 X 11 X 24**

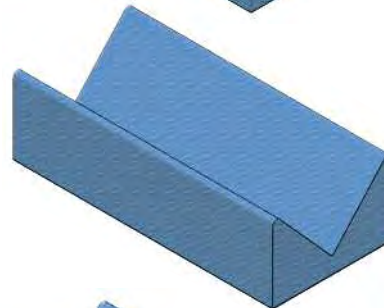

#UCCC
\$245.00

#UFCD
\$118.00

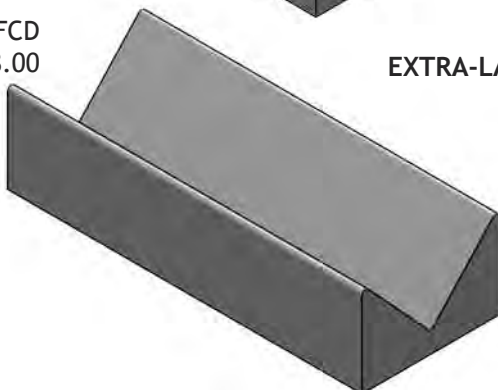

**EXTRA-LARGE EXTREMITY BLOCK
9 X 14 X 36**

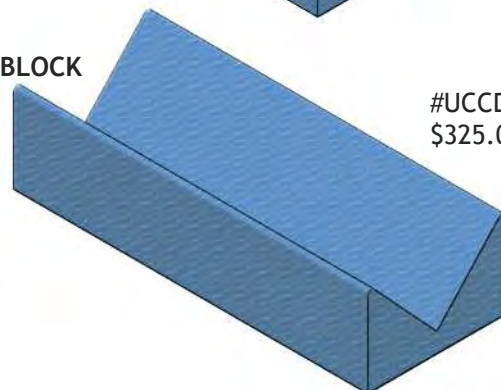

#UCCD
\$325.00

BARIATRIC POSITIONING SPONGES

HIGH-DENSITY SPONGE: These positioning blocks are specifically designed to provide extra firm support for bariatric and athletic patient positioning.

NON-COATED

COATED

(For COATED SPONGES ONLY: edges may appear on images.)

#UBAT
\$46.00

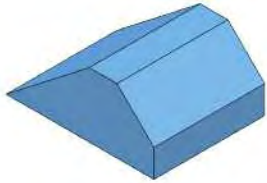

BARIATRIC TORSO BOLSTER
16 X 12 X 7

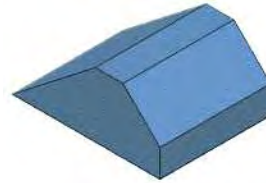

#UCAT
\$133.00

#UBBA
\$33.00

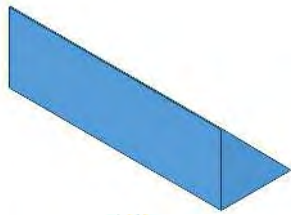

BARIATRIC 45° SPINAL WEDGE
7 X 21.25 X 7

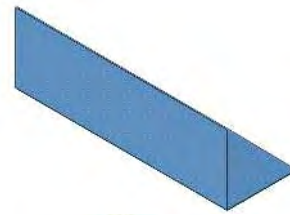

#UCBA
\$107.00

#UBBM
\$19.00

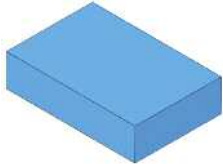

BARIATRIC RECTANGLE
8 X 12 X 3



#UCBM
\$53.00

#UBBP
\$79.00

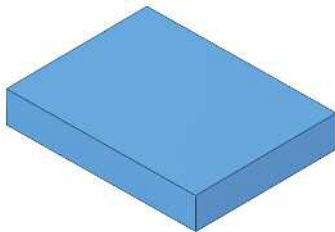

DECUBITUS PAD
18 X 24 X 4



#UCBP
\$179.00

SPECIALTY POSITIONING SPONGES

NON-COATED STANDARD GRAY SPONGE

COATED STANDARD SPONGE

(For COATED SPONGES ONLY: edges may appear on images.)

#UFBX
\$99.00

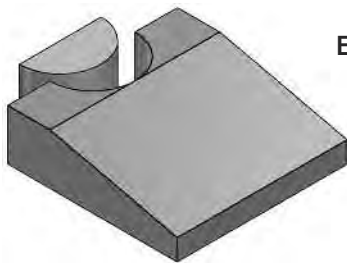

ENDO-ULTRASOUND WEDGE
20 X 20 X 6

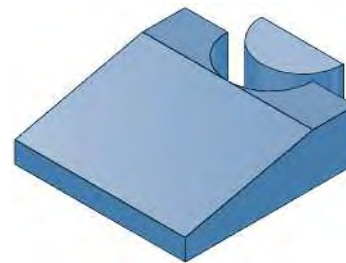

#UCBX
\$312.00

#UFBW
\$99.00

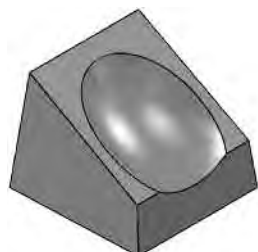

CT HEADREST
11 X 12.5 X 10

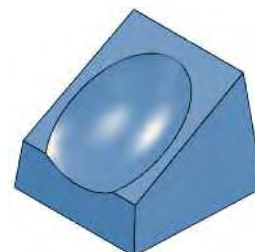

#UCBW
\$217.00

GENERAL SPONGE KITS

(For COATED SPONGES ONLY: edges may appear on images.)

NON-COATED STANDARD GRAY SPONGE

COATED STANDARD SPONGE

#UKGP
\$68.00

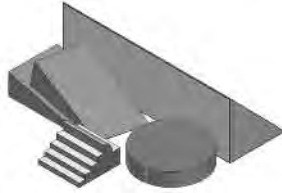

GENERAL KIT P

Uncoated *OR* Coated Kit includes:

UNCOATED	DESCRIPTION	COATED
UFBD	45° Spine Wedge (7x21.5x7)	UCBD
UFBI	15° Wedge (11x7x3)	UCBI
UFAK	Circular Head Block	UCAK
UFAA	Oblique Finger Block	UCAA

#USGP
\$272.00

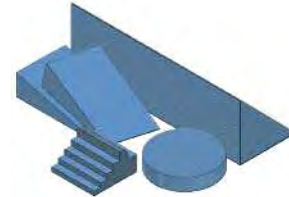

#UKGA
\$61.00



GENERAL KIT A

Uncoated *OR* Coated Kit includes:

UNCOATED	DESCRIPTION	COATED
UFAK	Circular Head Block	UCAK
UFBC	45° Wedge (7x7x7)	UCBC
UFBE	(2) 34° Wedge ((4x7x3)	UCBE
UFBI	(2) 15° Wedge (11x7x3)	UCBI
UFBL	Rectangle (7.5x10x3)	UCBL

#USGA
\$232.00

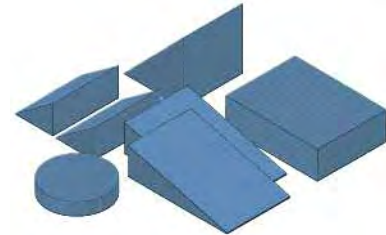

#UKGB
\$86.00

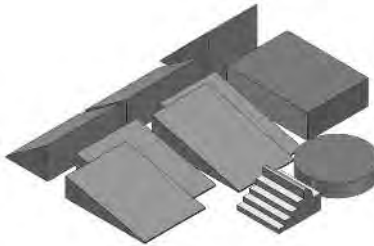

GENERAL KIT B

Uncoated *OR* Coated Kit includes:

UNCOATED	DESCRIPTION	COATED
UFAA	Adult Obl Finger Block	UCAA
UFAK	Circular Head Block	UCAK
UFBC	45° Wedge (7x7x7)	UCBC
UFBE	(2) 34° Wedge ((4x7x3)	UCBE
UFBI	(2) 15° Wedge (11x7x3)	UCBI
UFBJ	(2) 12° Wedge (9.5x7.25x2.25)	UCBJ
UFBL	Rectangle (7.5x10x3)	UCBL

#USGB
\$343.00

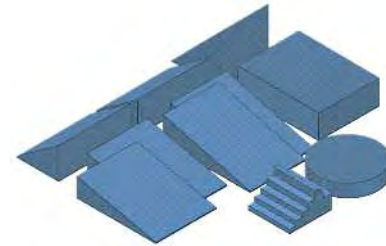

#UKGC
\$140.00

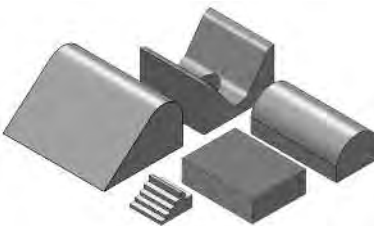

GENERAL KIT C

Uncoated *OR* Coated Kit includes:

UNCOATED	DESCRIPTION	COATED
UFAA	Adult Obl Finger Block	UCAA
UFAM	AP/PA Adult Head Holder	UCAM
UFAR	Cervical Head Rest	UCAR
UFAY	Angular Bolster	UCAY
UFBL	Rectangle (7.5x10x3)	UCBL

#USGC
\$369.00

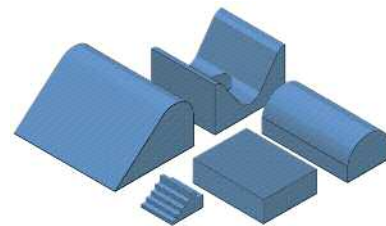

#UKGD
\$124.00



GENERAL KIT D

Uncoated *OR* Coated Kit includes:

UNCOATED	DESCRIPTION	COATED
UFAL	Head & Neck Support	UCAL
UFAN	AP/PA Child Head Holder	UCAN
UFAR	Cervical Head Rest	UCAR
UFBF	27° Wedge (10x10x6)	UCBF
UFBJ	(2) 12° Wedge (9.5x7.25x2.25)	UCBJ
UFBL	Rectangle (7.5x10x3)	UCBL

#USGD
\$326.00

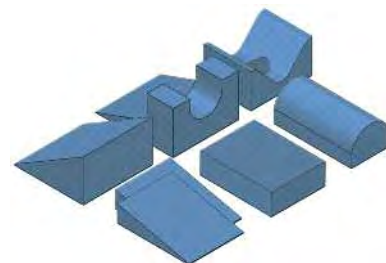

#UKGE
\$177.00



GENERAL KIT E

Uncoated *OR* Coated Kit includes:

UNCOATED	DESCRIPTION	COATED
UFAA	Adult Obl Finger Block	UCAA
UFAK	Circular Head Block	UCAK
UFAM	AP/PA Adult Head Holder	UCAM
UFBB	45° Wedge (7x14x7)	UCBB
UFBG	21° Wedge (10x10x4.63)	UCBG
UFBI	(2) 15° Wedge (11x7x3)	UCBI
UFBL	Rectangle (7.5x10x3)	UCBL
UFBN	Rectangle (14x18x3)	UCBN
UFBU	Multi-Angle Wedge	UCBU

#USGE
\$746.00



SPECIALTY SPONGE KITS

(For COATED SPONGES ONLY: edges may appear on images.)

NON-COATED STANDARD GRAY SPONGE

COATED STANDARD SPONGE

#UKWA
\$56.00



WEDGE KIT A

Uncoated OR Coated Kit includes:

UNCOATED	DESCRIPTION	COATED
UFBC	45° Wedge (7x7x7)	UCBC
UFBF	27° Wedge (10x10x6)	UCBF
UFBG	21° Wedge (10x10x4.63)	UCBG
UFBI	(2) 15° Wedge (11x7x3)	UCBI

#USWA
\$237.00

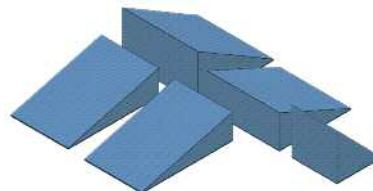

#UKWB
\$69.00



WEDGE KIT B

Uncoated OR Coated Kit includes:

UNCOATED	DESCRIPTION	COATED
UFBD	45° Spine Wedge (7x21.25x7)	UCBD
UFBE	(2) 34° Wedge ((4x7x3)	UCBE
UFBF	27° Wedge (10x10x6)	UCBF
UFBG	21° Wedge (10x10x4.63)	UCBG

#USWB
\$249.00

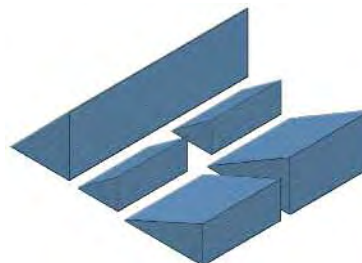

#UKRA
\$48.00



RECTANGLE KIT

Uncoated Kit includes:

UNCOATED	DESCRIPTION	COATED
UFBQ	(3) Rectangle (4x6x0.5)	N/A
UFBR	(3) Rectangle (4x6x1.0)	N/A
UFB S	(3) Rectangle (4x6x1.5)	N/A
UFBT	(3) Rectangle (4x6x2.0)	N/A

(Rectangle Kit A is unavailable in coated sponge.)

#UKOA
\$115.00

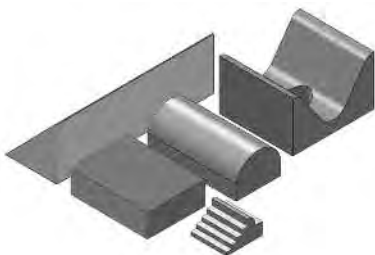

ORTHO KIT A

Uncoated OR Coated Kit includes:

UNCOATED	DESCRIPTION	COATED
UFAA	Adult Obl Finger Block	UCA A
UFAM	AP/PA Adult Head Holder	UCAM
UFAR	Cervical Head Rest	UCAR
UFBD	45° Spine Wedge (7x21.25x7)	UCBD
UFBL	Rectangle (7.5x10x3)	UCBL

#USOA
\$325.00

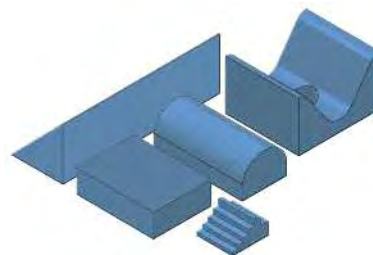

#UKOB
\$135.00

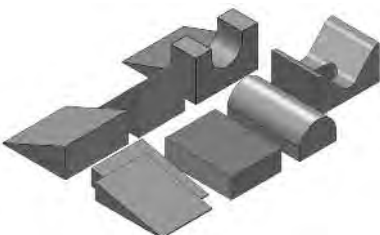

ORTHO KIT B

Uncoated OR Coated Kit includes:

UNCOATED	DESCRIPTION	COATED
UFAL	Head & Neck Support	UCAL
UFAN	AP/PA Child Head Holder	UCAN
UFAR	Cervical Head Rest	UCAR
UFBC	45° Wedge (7x7x7)	UCBC
UFBG	21° Wedge (10x10x4.63)	UCBG
UFBJ	(2) 12° Wedge (9.5x7.25x2.25)	UCBJ
UFBL	Rectangle (7.5x10x3)	UCBL

#USOB
\$362.00

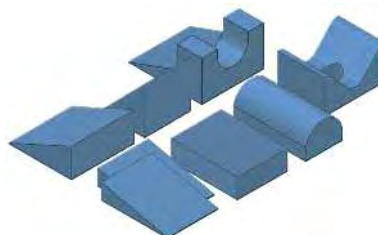

#UKOC
\$217.00



ORTHO KIT C

Uncoated OR Coated Kit includes:

UNCOATED	DESCRIPTION	COATED
UFAA	Adult Obl Finger Block	UCA A
UFAF	Adult Lateral Finger Block	UCAD
UFAD	Leg Immobilizer	UCA F
UFAH	Knee Arthrogram Block	UCA H
UFAK	Circular Head Block	UCA K
UFAL	Head & Neck Support	UCA L
UFAR	Cervical Head Rest	UCA R
UFBU	Multi-Angle Wedge	UCA U

#USOC
\$751.00

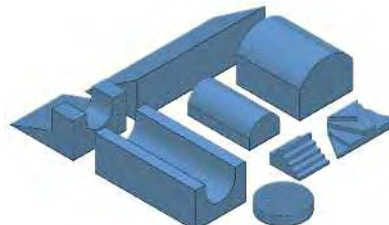

SPECIALTY SPONGE KITS

(For COATED SPONGES ONLY: edges may appear on images.)

NON-COATED
STANDARD GRAY SPONGE

COATED
STANDARD SPONGE

#UKCA
\$54.00



CLINIC KIT A
Uncoated OR Coated Kit includes:

UNCOATED	DESCRIPTION	COATED
UFBB	45° Wedge (7x14x7)	UCBB
UFAA	Adult Obl Finger Block	UCAA
UFAK	Circular Head Block	UCAK
UFBI	(2) 15° Wedge (11x7x3)	UCBI

#USCA
\$223.00



#UKCB
\$115.00

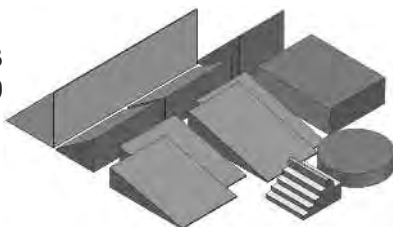

CLINIC KIT B
Uncoated OR Coated Kit includes:

UNCOATED	DESCRIPTION	COATED
UFAA	Adult Obl Finger Block	UCAA
UFAK	Circular Head Block	UCAK
UFBC	45° Wedge (7x7x7)	UCBC
UFBE	(2) 34° Wedge ((4x7x3)	UCBE
UFBI	(2) 15° Wedge (11x7x3)	UCBI
UFBJ	(2) 12° Wedge (9.5x7.25x2.25)	UCBJ
UFBL	Rectangle (7.5x10x3)	UCBL
UFBD	45° Wedge (7x21.5x7)	UCBD

#USCB
\$458.00

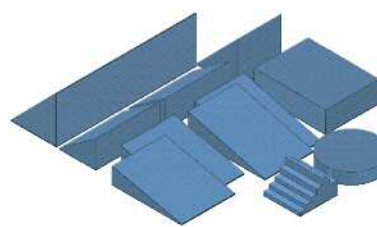

#UKPA
\$182.00



PEDIATRIC KIT
Uncoated Kit includes:

UNCOATED	DESCRIPTION	COATED
UFAC	Bilateral Child Obl Finger Block	UCAC
UFAE	Pediatric Lateral Finger Block	UCAE
UFAK	Circular Head Block	UCAK
UFAN	AP/PA Child Head Holder	UCAN
UFAQ	Child Head Immobilizer	UCAQ
UFAX	Child Myelogram Block	UCAX
UFBT	Rectangle (4x6x2)	N/A

#USPA
\$325.00
(USPA does not include the rectangle shown in the UKPA.)

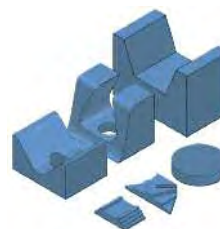

#UKBA
\$184.00
(UKBA uses the high-density bariatric foam as standard.)

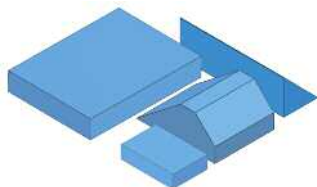

BARIATRIC KIT
Uncoated OR Coated Kit includes:

UNCOATED	DESCRIPTION	COATED
UBAT	Torso Bolster (16x12x7)	UCAT
UBBA	Spinal Wedge (7x21.5x7)	UCBA
UBBM	Rectangle (8x12x3)	UCBM
UBBP	Decubitus Pad (18x24x4)	UCBP

#USBA
\$533.00

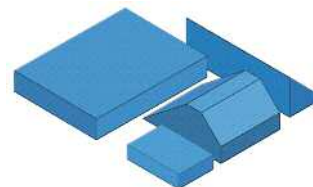

#UKCT
\$102.00



CT IMAGING KIT
Uncoated Kit includes:

UNCOATED	DESCRIPTION	COATED
UFBB	45° Wedge (7x14x7)	UCBB
UFBC	45° Wedge (7x7x7)	UCBC
UFBE	(2) 34° Wedge ((4x7x3)	UCBE
UFBF	27° Wedge (10x10x6)	UCBF
UFBG	21° Wedge (10x10x4.63)	UCBG
UFBI	(2) 15° Wedge (11x7x3)	UCBI
UFBJ	(2) 12° Wedge (9.5x7.25x2.25)	UCBJ
UFBW	CT Headrest	UCBW

#USCT
\$460.00

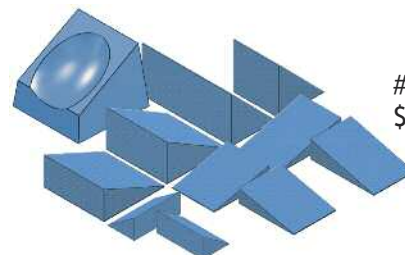

NEW!

#UKRC
\$95.00



ULTRASOUND KIT
Uncoated OR Coated Kit includes:

UNCOATED	DESCRIPTION	COATED
UFBL	(10) Rectangle (7.5x10x3)	UCBL

#USRC
\$395.00

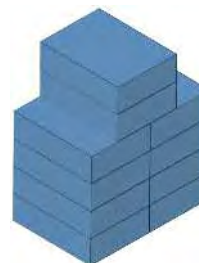

Bolster Blocks



#UVFA



#UVFB



#UVFG



#UVFH



#UVFJ

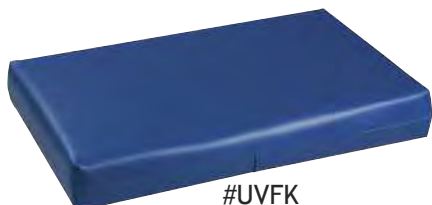

#UVFK

NEW!

- Firm, high-density urethane foam.
- Royal Blue outer cover is durable, heavy gauge, reinforced vinyl.
- Seams are sewn and tear resistant.
- Easy to clean.
- Bolsters are *NOT RADIOLUCENT*.
- Excellent support for a wide variety of imaging needs.

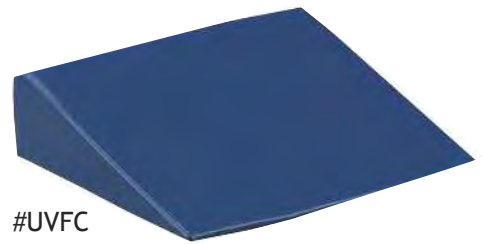

#UVFC



#UVFD

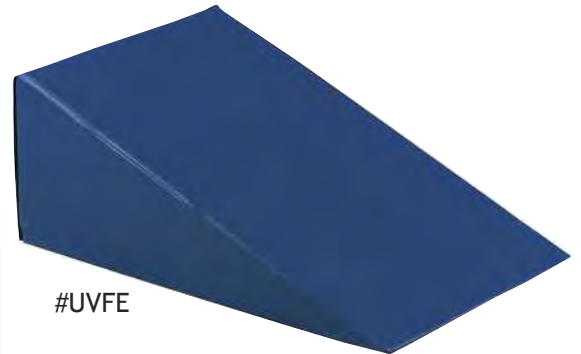

#UVFE

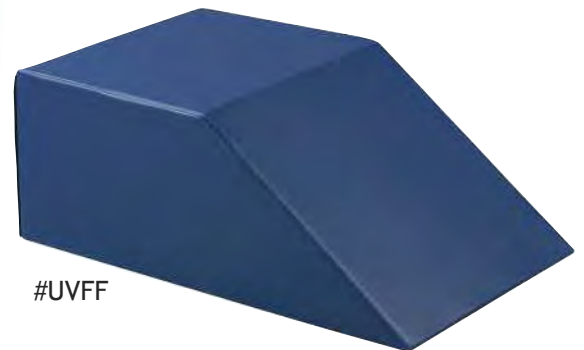

#UVFF

cat.#	w x l x d	price
UVFA	12" x 8" dia.	119.00
UVFB	8" x 18" x 6"	90.00
UVFC	24" x 18" x 6"	155.00
UVFD	8" x 16" x 8"	185.00
UVFE	20" x 32" x 12"	209.00
UVFF	20" x 32" x 12"	279.00
UVFG	8" x 12" x 6"	76.00
UVFH	12" x 14" x 3"	48.00
UVFJ	8" x 12" x 3"	62.00
UVFK	20" x 13" x 3"	72.00

Bolsters are NOT RADIOLUCENT

- Unique visco-elastic material molds to patient's body shape and conforms to table platform.
- Meets specific requirements for MRI compatibility and safety with excellent radiolucent qualities.
- Antimicrobial cover with anti-slip undersurface - easy to clean and maintain.

MRI Positioners

Rectangle (2)
#MFP-01

Rectangle (2)
#MFP-02

Rectangle (2)
#MFP-05

Wedge (2)
#MFP-03

Wedge (2)
#MFP-04

Curved Wedge (2)
#MFP-06

Neck Roll
#MFP-07

Knee Wedge
#MFP-010

Additional MRI Positioners can be found on page 56.

cat.#	w x l x d	price
MFP-01	14" x 3" x 1"	290.00
MFP-02	5" x 3" x 1"	290.00
MFP-03	10" x 10" x 3"	335.00
MFP-04	14" x 4" x 1.5"	335.00
MFP-05	3" x 4" x 2"	325.00
MFP-06	5.2" x 5.3" x 3"	350.00
MFP-07	3" x 7.3" x 2.3"	355.00
MFP-10	16" x 28.2" x 8"	685.00

MRI Table Pads

Highest Quality Solution for Patient Comfort and Safety for all MRI Exams!

GE 1.5T & 3.0T

cat.#	w x l x d	price
MFP-20	15" x 72" x 0.625"	325.00
MFP-22	15" x 72" x 1.250"	325.00
MFP-24	15" x 27" x 1.250"	790.00

(MFP-24 is two pcs)

GE 0.2T, 0.35 & 0.7T

cat.#	w x l x d	price
MFP-30	29" x 14" x 0.625"	330.00
MFP-32	29" x 14" x 1.250"	420.00
MFP-34	29" x 28" x 1.250"	1125.00

(MFP-34 is two pcs)

Hitachi

cat.#	w x l x d	price
MFP-40	31" x 13.5" x 0.625"	325.00
MFP-42	31" x 27.0" x 0.625"	700.00
MFP-44	27" x 13.5" x 0.625"	325.00
MFP-46	31" x 13.5" x 1.250"	355.00
MFP-48	31" x 27.0" x 1.250"	955.00

(MFP-42 & MFP-48 are two pcs)

Philips, Siemens, Toshiba

cat.#	w x l x d	price
MFP-50	19.5" x 14" x 0.625"	325.00
MFP-52	19.5" x 14" x 1.250"	325.00
MFP-54	19.5" x 28" x 1.250"	795.00

(MFP-54 is two pcs)

Other Positioners & Pads are available. Call for quote.

MRI Positioner/Pad Complete Kits

#MFP-GE2

#MFP-GE3

#MFP-GE5

#MFP-GE4

#MFP-GE7

#MFP-HT1

#MFP-ST2

#MFP-PST

#MFP-PT3

#MFP-GNK
(Includes: MFP-01, MFP-02, MFP-03, MFP-04, MFP-05, MFP-06)

#MFP-BBK

cat.#	MRI Kit Description (# pieces)	price
MFP-GNK	General MRI Kit	1935.00
MFP-GE2	CTL Coil Pad Kit: GE 1.5T (2)	810.00
MFP-GE3	Table Pad Kit: GE 1.5T, 3.0T (3)	1245.00
MFP-GE5	Table Pad Kit: GE 1.5T, 3.0T (5)	1875.00
MFP-GE4	Table Pad Kit: GE .2T, .35T, .7T (5)	2350.00
MFP-GE7	Table Pad Kit: GE .2T, .35T, .7T (3)	1695.00
MFP-HT1	Table Pad Kit: Hitachi (7)	3065.00
MFP-ST2	Table Pad Kit: Philips, Siemens, Toshiba (5)	1875.00
MFP-PST	Table Pad Kit: Philips, Siemens, Toshiba (3)	1240.00
MFP-PT3	CTL Coil Pad Kit: Philips 1.5T (2)	810.00
MFP-BBK	Breast Biopsy Positioning Kit (10)	2185.00

Sandbags

- All sandbags are filled with sand and are ready to use.
- Heat sealed inner sleeve prevents the leakage of sand.
- All seams are sewn and tear resistant.
- Deep green outer cover is heavy gauge, reinforced vinyl.
- Every sandbag includes a reinforced webbing handle.



Custom Sizes Available!

Includes weight ID tag.



2-lb
4" x 9"
#SBP-02
\$22.00



3-lb
5" x 9"
#SBP-03
\$22.00



5-lb
7" x 9"
#SBP-05
\$28.00



5-lb
5" x 12"
#SBF-05
\$28.00



5-lb
9" x 9"
#SBC-05
\$28.00



7-lb
10" x 10"
#SBG-07
\$32.00



7-lb
6" x 14"
#SBF-07
\$32.00



10-lb
7" x 16"
#SBF-10
\$34.00



10-lb
11" x 11"
#SBC-10
\$34.00



10-lb
11" x 11"
#SBC-HL
\$45.00

NEW!



AC Joint Sandbag with wrist grip
10-lb
11" x 11"
#SBC-AC
\$42.00



15-lb
12" x 12"
#SBG-15
\$39.00



20-lb
12" x 14"
#SBC-20
\$39.00

Sandsocks

- Sandsocks are loosely filled sandbags that contour to a broad range of shapes and forms.
 - Stabilizes hard-to-hold and irregular anatomy.
 - No need for additional person to hold the patient.
 - Double seams for strength and longevity.
 - Flexible, heavy gauge, reinforced vinyl.
- (Sorry, sandsocks are not available in Varsity material.)



Sandsocks are only available in "honey" color.



Includes weight ID tag.

1-lb 2" x 8"

#SBS-01
\$28.00 ea.



3-lb 4" x 12"

#SBS-03
\$29.00 ea.



5-lb 5" x 15"

#SBS-05
\$33.00 ea.



10-lb 6" x 20"

#SBS-10
\$36.00 ea.



12-lb 6" x 25"

#SBS-12
\$39.00 ea.



Sandbag Kits *(Save over ordering individually!)*



5-lb cervical

#SBK-CA (Standard) \$53.00 set
Set: (2) 5-lb/9" x 9"



10-lb cervical

#SBK-CB (Standard) \$64.00 set
Set: (2) 10-lb/11" x 11"



20-lb cervical

#SBK-CC (Standard) \$74.00 set
Set: (2) 20-lb/12" x 14"



10-lb AC Joint w/wrist grips

#SBK-AC (Standard) \$80.00 set
Set: (2) 10-lb/11" x 11"



10-lb w/handles

#SBK-HL (Standard) \$85.00 set
Set: (2) 10-lb/11" x 11"



general set (a)

#SBK-GA (Standard) \$219.00 set
Set: (2) 3-lb/5" x 9" (2) 7-lb/6" x 14"
(1) 5-lb/5" x 12" (2) 10-lb/11" x 11"
(1) 5-lb/7" x 9"



general set (b)

#SBK-GB (Standard) \$169.00 set
Set: (2) 3-lb/5" x 9"
(2) 7-lb/6" x 14"
(2) 10-lb/11" x 11"



sandsock kit

#SBK-SA \$157.00 set
Set: (1) 1-lb/2" x 8" (1) 10-lb/6" x 20"
(1) 3-lb/4" x 12" (1) 12-lb/6" x 25"
(1) 5-lb/5" x 15"



athletic/bariatric

#SBK-AA (Standard) \$199.00 set
Set: (2) 7-lb/10" x 10"
(2) 10-lb/7" x 16"
(2) 20-lb/12" x 14"

NEW!



Sandbags not included

Mobile Sandbag Rack

#SBM-100 \$299.00

- Organize & store all sizes of sandbags for easy retrieval.
- 2-sided panel includes 20 hanging hooks.
- Solid base shelf on both sides.
- 3" swivel casters for easy mobility.
- 53"h x 25"w x 19"d.



Transfer Boards

- Allows safe and efficient transfer of patients for general imaging, MRI, and CT.
- Durable, semi-rigid, slick material makes positioning under the patient easy.
- Transfer boards are radiolucent can be used in the imaging field. 
- Conveniently located 1½" x 4½" hand-holds allow optimal movement.
- Regular Boards are made of ¾" thick HDPE (high density polyethylene).
- Regular board color is white.
- Transfer boards ship at OverSize rates.

REGULAR BOARDS

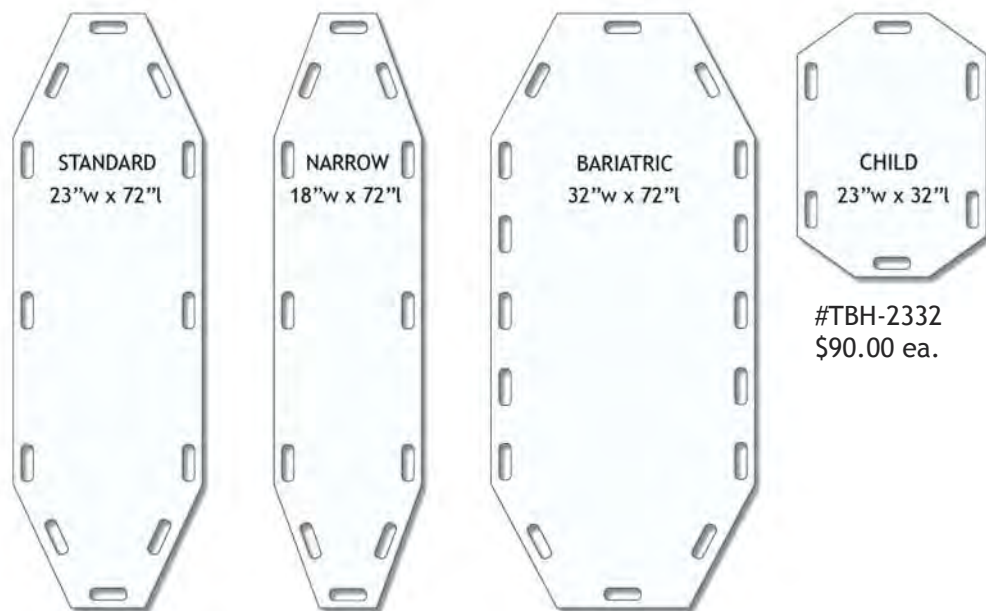

- #TBS-2372
Qty 1-4: \$185.00 ea.
Qty 5-9: \$160.00 ea.
Qty 10+: \$135.00 ea.
- #TBN-1872
Qty 1-4: \$165.00 ea.
Qty 5-9: \$150.00 ea.
Qty 10+: \$130.00 ea.
- #TBB-3272
Qty 1-4: \$235.00 ea.
- #TBH-2332
\$90.00 ea.

ANTI-STATIC BOARDS



cat.#	description	price
TBS-2372AS	standard	255.00
TBN-1872AS	narrow	245.00
TBB-3272AS	bariatric	575.00
TBH-2332AS	half-size	110.00

- Anti-static boards are made of UHMW (ultra high molecular weight polyethylene).
- Anti-static boards are black.
- Standard, Narrow, and Bariatric boards ship at OverSize rates.

Flexible Transport Mover

- Rated up to 1500-lbs and can be used alone or with an inserted standard or narrow transfer board (not included).
- Intended for limited use and should be replaced regularly.
- Ideal for large or incapacitated patients.
- Non-woven poly, latex-free mover is 80" x 40".

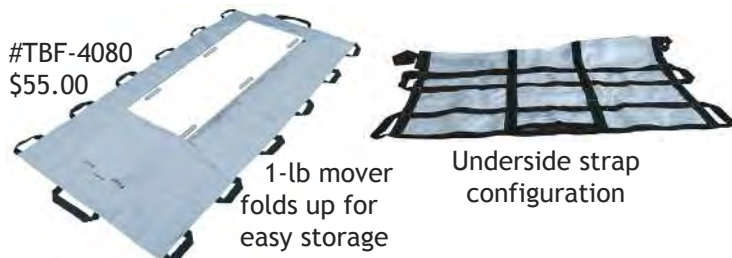

Board Wall Rack



#TBR-2P
\$53.00

- Two 6" pegs are angled to keep board from slipping.
- Mounting holes are on vertical centers.
- Steel with white enamel.
- Ships @ 4 lbs.



Lifting Straps

#TBS-ST2
\$30.00/pair

- Convenient nylon straps loop through hand holds.
- Provides better grip.
- Provides extra length for better reach.
- Ships @ 1 lb.

Restraint Straps



- Super strong 2" nylon webbing.
- Secure snap buckle closure.

cat.#	girth	description	price ea.
TBR-S72	72"	standard/half	35.00
TBR-N60	60"	narrow	30.00
TBR-B90	90"	bariatric	40.00

Radiolucent Immobilizer Strap



- Comfortably secures patient position and eliminates motion.
- Helps prevent patient falls without limiting respiration or circulation.
- Ideal for MRI, CT, and Radiology dept.
- Available in 3 widths and 5 lengths for a variety of patients and tables.

- Strap is heavy gauge reinforced vinyl.
- Fast and easy hook and loop closure.
- Easy to remove in case of emergency.



Available Colors

- Blue (default)
- Black
- Green
- Yellow

BLUE is the default color.

Colors are for Immobilizer Straps only. Hook and Loop is black.

cat.#	width x length	price
RDH-060	7" x 60"	75.00
RDH-072	7" x 72"	85.00
RDH-084	7" x 84"	105.00
RDH-096	7" x 96"	125.00
RDH-120	7" x 120"	160.00
RDP-060	14" x 60"	115.00
RDP-072	14" x 72"	125.00
RDP-084	14" x 84"	145.00
RDP-096	14" x 96"	165.00
RDP-120	14" x 120"	210.00
RDW-060	20" x 60"	145.00
RDW-072	20" x 72"	155.00
RDW-084	20" x 84"	175.00
RDW-096	20" x 96"	195.00
RDW-120	20" x 120"	240.00

Universal Restraint

- Universal clamp fits onto most imaging tables.
- 6" nylon strap firmly and comfortably holds the patient to the table with hook and loop closure.
- Brackets are stainless steel for long life.



Extremity Restraint Strapping

- Allows you to customize your restraint needs.
- Each package contains one 30-foot roll of "hook" and one 30-foot roll of "loop" strapping.
- Can be used on patients or equipment.



cat.#	color	width x length	price
RDT-230	Black	2" x 30-ft	50.00
RDT-233	Blue	2" x 30-ft	55.00
RDT-430	Black	4" x 30-ft	110.00
RDT-433	Blue	4" x 30-ft	115.00

Traction Straps

MANUAL #RDT-HN \$99.00

- Straightening the legs easily applies traction.
- Hook and loop hand-hold straps provide secure grip.



Lowers shoulders for cervical imaging.

AUTOMATIC #RDT-SH \$160.00

- Primarily for elderly or unconscious patients.
- Rigid foot plate provides stable, steady support.



Table Pads

- Pads can be used for imaging tables or stretchers.
- Fabricated for durability and longevity.
- Helps maintain complete control of the patient.
- Affordable for each room and table. 

- Heavy gauge vinyl covering with welded seams.
- Color: light blue.
- Two brass eyelets in each end for hanging.
- Soft and comfortable.
- Cleans easy with mild cleaner or germicide.
- NOTE: table pads over 1 1/4" (32mm) thick for diagnostic imaging are NOT recommended.



Standard Table Pad

#PAD-51
\$109.00

72" x 23 1/4" x 1"
Ships @ 7 lbs.

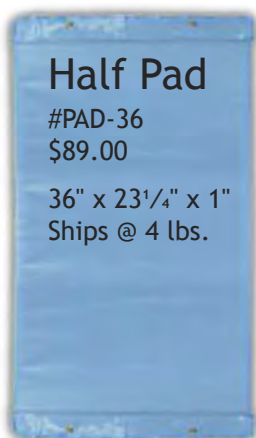

Half Pad

#PAD-36
\$89.00

36" x 23 1/4" x 1"
Ships @ 4 lbs.



Standard Table Pads

72" x 23 1/4" x 1"

cat.#	color	covering	price
PAD-51	Light Blue	Standard Vinyl	\$109.00
PAD-53	Green	Reinforced Vinyl	\$189.00
PAD-55	Black	Reinforced Vinyl	\$189.00
PAD-50	Blue	Reinforced Vinyl	\$189.00
PAD-52	Yellow	Reinforced Vinyl	\$189.00
PAD-80	See Page 25	Nylon Fabric	\$159.00

(Edge of pads may show up on some images.)

Pad Storage Rack & Set



- Two hooks on 12" centers.
- Mounts on 16" centers.
- Steel with white finish.
- Ships @ 4 lbs.

#PAD-R2 \$ 53.00 RACK ONLY

#PAD-S1 \$145.00 COMBO SET

(Combo Set includes: Standard Pad & Rack)

Custom Pads

#PAD-SP Prices start at \$209.00

- Rectangular pads made to your specs.
- Submit length" x width" x thickness".
- Pads larger than 80"long x 30"wide x 2"thick may require further quote.
- Custom Pads are NON-RETURNABLE.

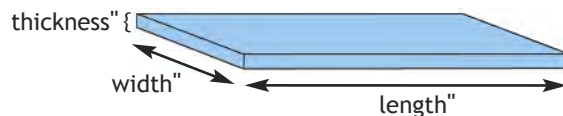

Techno-Tuff™ Table Pads

- Constructed of durable mesh laminate reinforced vinyl.
- 72" x 23" x 1" pad is radiolucent.
- Handles allow patients to be easily moved from stretcher to table.
- Low-friction, water proof, stain proof, and antimicrobial.

cat.#	color	description	price
PAD-H8R	Royal Blue	With Handles	\$275.00
PAD-H8K	Black	With Handles	\$275.00
PAD-X8R	Royal Blue	No Handles	\$245.00
PAD-X8K	Black	No Handles	\$245.00



Leg Support



#LGS-09
\$495.00

- Safely supports and positions patient leg.
- Easy to use Posi-Lock height adjustment.
- Lift height range: 14½" to 19".
- 6½" x 9½" calf support comes with nylon covered pad.
- All steel frame with sturdy 9" x 12" base.
- Shipping weight: 14 lbs.



- Provides true 90° Lateral View of Hip.
- Unobstructed Femoral Head and Neck.

Bariatric Leg Support

#LGS-B11
\$535.00



- Same as LGS-09, except:
- Extra large 15" x 18" base.
 - Shipping weight: 19 lbs.



Lateral Chest Support

#RLC-36 (36" tall support)
\$925.00

#RLC-48 (48" tall support)
\$965.00

- Height adjustable bar provides stability for patients of almost every height.
- Helps reduce re-takes.
- Cast aluminum base easily mounts to the wall.
- Repositionable aluminum bar is comfortable to grip.



Caliper

#CAL-21
\$57.00

- Accurately measures body thickness to be x-rayed, up to 21" in depth.
- Calibrated in both inches and cm.
- Made of durable aluminum.
- 1" wide x 21¼" tall x 10⅛" le.
- Ships @ 1 lb.



Head Immobilizer

- Safely supports and positions patient head.
- Solid steel angles with soft, vinyl covered cushions.
- Blocks with handles weigh 15-lbs each.
- Cushions: 8" w x 6" h x 3" d.
- Shipping weight: 32 lbs.

#RHI-AB
\$250.00

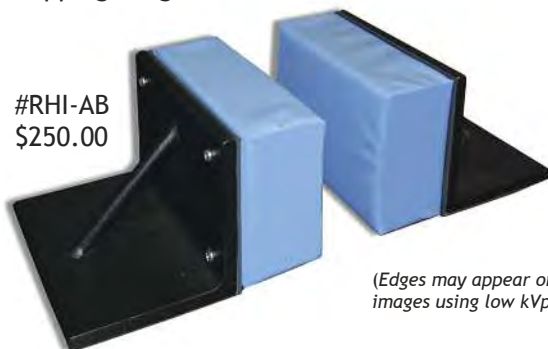

(Edges may appear on images using low kVp.)

Head Paddles

- Ideal for a designated person to keep patient's head comfortable and steady.
- Rigid vinyl discs with comfort-grip handles.
- Coated foam cushions: 7" dia. x 1½" thick.
- Shipping weight: 4 lbs.

#RHI-CP
\$84.00



T-Spray II™

#PDC-507 \$114.00/case

For general use and is ideal for **Ultrasound** transducers, probes and **all other equip.**



Both Sprays:

- Use after each patient.
- Contains NO alcohol, phenol, glutaraldehyde.
- Effective bactericide, fungicide, & virucide.
- **Kills MRSA, Avian Flu & HIV-1.**
- Concentrated; just add water.
- 250ml bottles (1-dozen per case).

M-Spray™

#PDM-509 \$114.00/case

For **Mammography** compression plates, receptors & equip.



Lint-Free Wipes

#LFW-2P (1785 total wipes)
\$189.00/case of 15 boxes

- All-purpose 11½" x 12" lint-free wipes.
- Excellent for cleaning equipment, CR-receptors and computers.
- 119 white wipes/dispenser.



Germicidal Wipes



SUPER SANI-CLOTH® Wipes

- Contains the highest range of effectiveness.
- Cleans, disinfects, deodorizes.
- Alcohol content: High @ 55%.
- Recommended Contact Time: 2-minutes or less.
- Popular industry choice for most **IMAGING EQUIPMENT**.
- Also recommended for **KEYBOARDS and APRONS**.
- Meets CDC, OSHA and CMS Tag F441 guidelines.

cat.#	wipe size	quantity	price
GWP-P55	6" x 6¾"	tub of 160 wipes	\$12.50
GWP-P55CS	6" x 6¾"	case of 12 tubs	\$153.00
GWP-PL55	7½" x 15"	tub of 65 wipes	\$15.00
GWP-PL55CS	7½" x 15"	case of 6 tubs	\$90.00
GWP-PW55	5" x 8"	box of 50 packets	\$14.80
GWP-PW55CS	5" x 8"	case of 10 boxes	\$148.00
GWP-PT55	11½" x 11¾"	box of 50 packets	\$46.00
GWP-PT55CS	11½" x 11¾"	case of 3 boxes	\$138.00



SANI-CLOTH® AF3 Alcohol-Free Wipes

- Contains an excellent range of effectiveness.
- Cleans, disinfects, deodorizes & fragrance-free.
- Alcohol content: ALCOHOL-FREE (less than 0.016%).
- Recommended Contact Time: 3-minutes or less.
- Commonly used for **MAMMOGRAPHY, ULTRASOUND and most other IMAGING EQUIPMENT**.
- Meets CDC, OSHA and CMS Tag F441 guidelines.

cat.#	wipe size	quantity	price
GWP-WAF	6" x 6¾"	tub of 160 wipes	\$13.50
GWP-WAFCS	6" x 6¾"	case of 12 tubs	\$162.00
GWP-WLAF	7½" x 15"	tub of 65 wipes	\$16.50
GWP-WLAFCS	7½" x 15"	case of 6 tubs	\$99.00
GWP-WWAF	5" x 8"	box of 50 packets	\$15.80
GWP-WWAFCS	5" x 8"	case of 10 boxes	\$158.00
GWP-WTAF	11½" x 11¾"	box of 50 packets	\$49.00
GWP-WTAFCS	11½" x 11¾"	case of 3 boxes	\$147.00



Mammography Exam Capes

- Maintains patient modesty and confidence.
- Provides protection against cross-contamination.
- Comfortable, non-irritating materials.
- Eliminates laundry and replacement costs.



Pink Cape

#GMC-22
\$46.00/case

- Open front/back.
- Soft 3-ply tissue.
- Size: 30" x 21".
- Color: PINK.
- 100 capes per case.



White Cape

#GMC-21
\$39.00/case

- Open front/back.
- Soft 3-ply tissue.
- Size: 30" x 21".
- Color: WHITE.
- 100 capes per case.



Standard Exam Gown

#GXE-55
\$46.00/case

- Open front/back w/ties.
- Soft tissue/poly/tissue.
- Regular size: 30" x 42".
- Color: BLUE.
- 50 gowns per case.



Extrasize Exam Gown

Size: XL
#GXX-58
\$75.00/case

- Open sides w/ties.
- Tissue/poly/tissue.
- Size: 40" x 40".
- Color: BLUE.
- 25 per case.



Stretcher Sheets

#GSS-49
\$61.00/case

- Soft and water resistant.
- 2-ply tissue/poly.
- Size: 40" x 90".
- Color: WHITE/BLUE.
- 50 sheets per case.



Pillow Cases

#GPC-23
\$55.00/case

- Soft and water resistant.
- 2-ply tissue/poly.
- Size: 21" x 30".
- Color: BLUE.
- 100 cases per case.

REFERENCE: Merrill's Atlas of Radiographic Positioning and Procedures, 9780323073219, text extract, "Each radiograph must include an appropriate marker that clearly identifies the patient's right (R) or Left (L) side. Medico-legal requirements mandate that these markers be present. R and L markers must be used with CR and DR digital imaging. The development of digital imaging and the use of CR and DR have enabled an environment in which the R and L markers can be placed on the image electronically. This is not recommended because of the great potential for error and legal implications. Anatomic markers should be placed on the CR cassette or DR table similar to screen-film cassettes."



#1E \$20.00 ea. set
R & L - 5/8"
2 initials - 3/8" or 3 initials - 1/4"
Without initials, order:
#4E @ \$12.80/set



#2E \$25.00 ea. set
RIGHT & LEFT - 1/2" 2-3 initials - 1/4"
Without initials, order:
#122E @ \$20.00/set

WORD and ARROW
Markers are on page 86!

Personal Touch Markers
are on pages 80-82!



#7E \$23.00 ea. set
R & L - 1"
2 initials - 3/8" or 3 initials - 1/4"
Without initials, order:
#5E @ \$14.70/set



#6EB \$25.00 ea. set
R & L - 1/2", arrow - 1", 2-3 initials - 1/4"
Without initials, order:
#6EA @ \$18.00/set

Beads Indicate Patient Position



#TA-13 \$30.00 ea. set
Elite Style R & L - 5/8"
2 initials - 3/8" or 3 initials - 1/4"



#TA-14 \$25.00 ea. set
Elite Style R & L - 5/8"
No initials

Elite Position Indicator Markers



#TA-137 \$32.00 ea. set
Elite Style R & L - 1/2"
2 initials only - 1/4"

Without initials, order:
#TA-18 @ \$27.00/set

- Elite markers have the most DURABLE aluminum casing.
- RED for "R" markers and misc. words / BLUE for "L" markers.
- Provides the best in QC!
- Identifier markers have high-impact polystyrene casing.
- Enhances quality control with fewer repeat exams.
- Provides basic, yet personalized image identification.



#TA-1 \$18.00 ea. set
R & L - 5/8"
2 initials - 3/8" or 3 initials - 1/4"
Without initials, order:
#TA-4 @ \$11.40/set



#TA-2 \$24.00 ea. set
Right & Left - 1/2"
2 or 3 initials - 1/4"
Without initials, order:
#TA-122 @ \$20.00/set

WORD and ARROW
Markers are on page 86!

Personal Touch Markers
are on pages 80-82!



#TA-7 \$22.00 ea. set
R & L - 1"
2 initials - 3/8" or 3 initials - 1/4"
Without initials, order:
#TA-5 @ \$12.30/set



#TA-002 \$18.00 ea. set
R & L - 5/8"
2 initials - 3/8" or 3 initials - 1/4"
Without initials, order:
#TA-001 @ \$11.40/set



#TA-17 \$35.00 ea. set
Identifier Style R & L - 7/8" Position
2 initials - 3/8" or 3 initials - 1/4"

Identifier Position Indicator Markers



#TA-16 \$30.00 ea. set
Identifier Style R & L - 7/8" Position
No initials

Personal Touch Colors

Who said work had to be boring?



RED/BLUE SOLID
 #TA-1 \$18.00 ea. set
 R & L - 5/8"
 2 initials - 3/8" or 3 initials - 1/4"



PURPLE SOLID
 #PT-CP \$18.00 ea. set
 R & L - 5/8"
 2 initials - 3/8" or 3 initials - 1/4"



YELLOW SOLID
 #PT-CY \$18.00 ea. set
 R & L - 5/8"
 2 initials - 3/8" or 3 initials - 1/4"



BURNT SIENNA SOLID
 #PT-CS \$18.00 ea. set
 R & L - 5/8"
 2 initials - 3/8" or 3 initials - 1/4"



GREEN SOLID
 #PT-CG \$18.00 ea. set
 R & L - 5/8"
 2 initials - 3/8" or 3 initials - 1/4"



ORANGE SOLID
 #PT-CO \$18.00 ea. set
 R & L - 5/8"
 2 initials - 3/8" or 3 initials - 1/4"

Personal Touch Tie-Dye



RED/BLUE/PURPLE TIE-DYE
 #PT-TR \$18.00 ea. set
 R & L - 5/8"
 2 initials - 3/8" or 3 initials - 1/4"



YELLOW/RED/ORANGE TIE-DYE
 #PT-TY \$18.00 ea. set
 R & L - 5/8"
 2 initials - 3/8" or 3 initials - 1/4"



BLUE/YELLOW/GREEN TIE-DYE
 #PT-TB \$18.00 ea. set
 R & L - 5/8"
 2 initials - 3/8" or 3 initials - 1/4"

Personal Touch Glitter

Have fun in what you do!



RED/BLUE GLITTER
 #PT-GR \$18.00 ea. set
 R & L - 5/8"
 2 initials - 3/8" or 3 initials - 1/4"



PURPLE GLITTER
 #PT-GP \$18.00 ea. set
 R & L - 5/8"
 2 initials - 3/8" or 3 initials - 1/4"



YELLOW GLITTER
 #PT-GY \$18.00 ea. set
 R & L - 5/8"
 2 initials - 3/8" or 3 initials - 1/4"



BURNT SIENNA GLITTER
 #PT-GS \$18.00 ea. set
 R & L - 5/8"
 2 initials - 3/8" or 3 initials - 1/4"



GREEN GLITTER
 #PT-GG \$18.00 ea. set
 R & L - 5/8"
 2 initials - 3/8" or 3 initials - 1/4"



ORANGE GLITTER
 #PT-GO \$18.00 ea. set
 R & L - 5/8"
 2 initials - 3/8" or 3 initials - 1/4"



PINK GLITTER
 #PT-GA \$18.00 ea. set
 R & L - 5/8"
 2 initials - 3/8" or 3 initials - 1/4"



LIGHT BLUE GLITTER
 #PT-GB \$18.00 ea. set
 R & L - 5/8"
 2 initials - 3/8" or 3 initials - 1/4"

Personal Touch Shapes



TROPICAL FISH
#PT-FRB \$20.00 ea. set



SKULLS
#PT-SKW \$20.00 ea. set

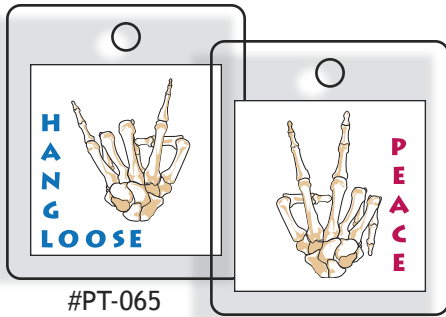

#PT-065

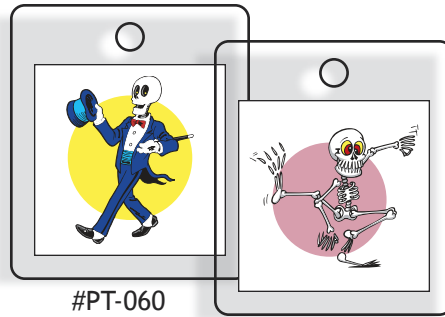

#PT-060

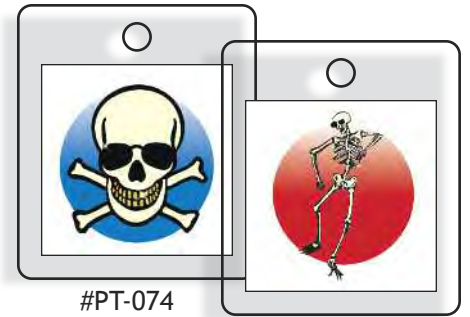

#PT-074

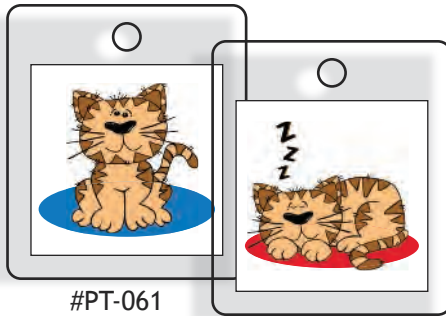

#PT-061

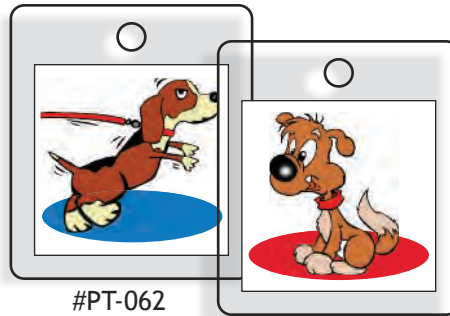

#PT-062

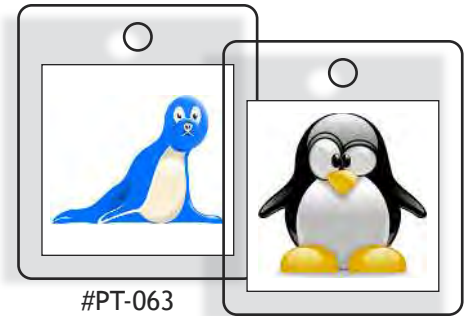

#PT-063

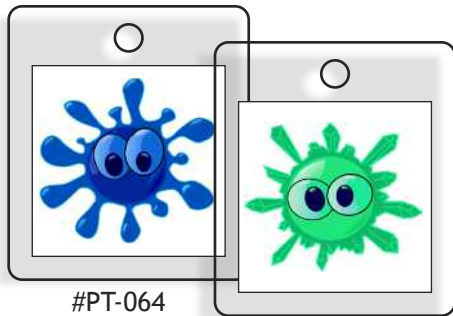

#PT-064

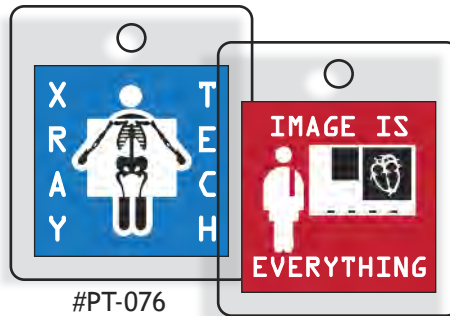

#PT-076

Personal Touch Photos

\$25.00 ea. set

(All Photo Markers are shown actual size.)

Photo Markers have a clear frame and are available with or without initials.

Custom Photo Marker Set

With your mailed-in order, include two different photos (non-returnable) of your kids, pets, etc. The area of each photo you want in your markers must be within a 1" square. We will cut out your photos and construct them into your own unique personal marker set.

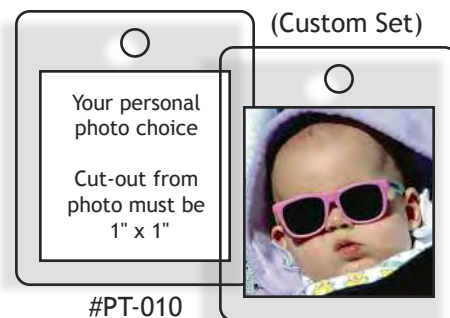

#PT-010

(Custom Set)

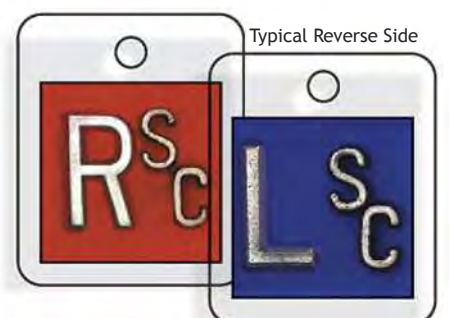

Typical Reverse Side

Digital Imaging Markers

Make accurate comparisons between life-size (what you see) and image-size (what you get)!

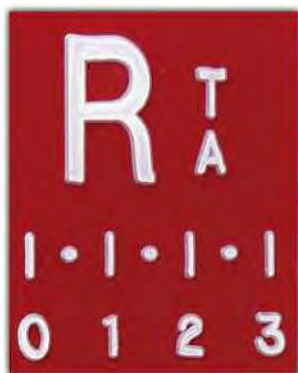

#1DR \$46.00 ea. set
Digital Style R & L - 3/4"
2 or 3 initials - 1/4"

- Each marker has a lead 3cm ruler.
- Color coded: L-Blue, R-Red.
- High density lead characters.

Specially Designed for Digital Imaging



#2DR \$46.00 ea. set
Digital Style R & L - 1/2"
2 or 3 initials - 1/4"

The personalized R & L marker sets or the stand alone 3cm ruler are specifically designed for Teleradiology, CR and DR Imaging, where the image-size does not always match the life-size anatomy.

Place a marker on the CR or DR Plate and capture the radiographed anatomy. The image of the unique 3cm ruler gives an immediate visual and measureable cue as to the size of the screen image compared to the life size anatomy.



#3DR \$28.00 ea.
Digital Style Ruler only

Wafer-Thin Digital Imaging Markers

Other Wafer-Thin markers are on p. 84!



#WTS-DR \$29.00 ea. set
Digital Style R & L with 3cm spacing

Super Thin for Slim Bucky Clearance

- Perfect for newer equipment (CR, DR, etc.) with very thin bucky clearance.
- Exceptionally thin markers: ³/₃₂" (2mm).
- Copper filtered for a broad range of KV.
- Elite style and color-coded.

Radi-O-Paque Extremity Rulers

45cm
#CPT-R45
\$175.00/ea.



115cm
#CPT-R115
\$275.00/ea.



- Sturdy 1 1/4" wide x 1/8" thick.
- High density lead letters.
- Brilliant YELLOW color.
- Spaced in 0.5cm increments.

Enlarged View

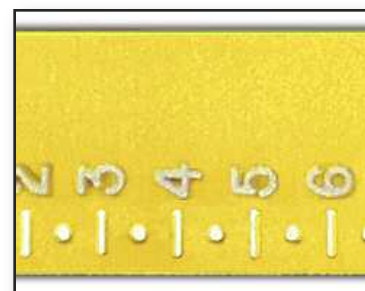

Wafer Thin



#WTS-1 \$29.00 ea.set
R & L - 3/8" 2 initials - 3/16"
Without initials, order:
#WTS-4 @ \$19.00/set



#WTS-6B \$29.00 ea.set
R & L - 3/8" 2 initials - 3/16"
Without initials (with arrow), order:
#WTS-6A @ \$19.00/set



#WTS-6C \$29.00 ea.set
R & L - 3/8" 2 initials - 3/16"
Without initials, order:
#WTS-6D @ \$19.00/set



WTW-A3 (1/2" arrow) \$9.00

Super Thin for Slim Bucky Clearance

- Perfect for newer equipment (CR, DR, etc.) with very thin bucky clearance.
- Exceptionally thin markers: <math>< 3/32</math> (2mm).
- Copper filtered for a broad range of KV.
- Elite style and color-coded.



(See Wafer Thin Words on p.86)



#RO-107B \$30.00 ea.set
R & L - 3/4" 2 initials - 3/8"
Without initials, order:
#RO-107A @ \$21.50/set

Oncology, CT and CR

- 1/4" super thick, high-density lead letters.
- Designed for Oncology and Industry, and other applications.
- Elite style markers, color-coded and Techno-Aide tough.

Vinyl & Epoxy encased, for longer life!



Ex.: ROW-23 3/4" letters (1/4"thick)

Super Thick for High Radiation

The Oncology markers are 1/4" thick and will NOT fit in most low clearance bucky trays.

description	cat.# (1/4")	price
single letter	ROW-01	\$11.00
2-3 letters	ROW-23	\$14.00
4-5 letters	ROW-45	\$16.00
6-7 letters	ROW-67	\$19.00
8+ letters	ROW-80	\$22.00



#COP-1 \$38.00 set ELITE
(2 sets of 1E markers: 1 set with copper filter, 1 set without.)

Copper Filtered

- Copper filtered for High KV.
- High density lead letters.
- Available in ELITE or IDENTIFIER.
- Color-coded, impact resistant.
(Should not be used for mammography.)

Filtered for High KV Exams



#COP-2 \$35.00 set ELITE
R & L - 1/2", 2-3 initials - 1/4"
(Filtered & unfiltered on the same marker.)

Stencil Clipper

Plated Steel Clipper



#XSCP-10
\$15.00 ea.

Stenciled
non-personalized
R & L.

Elite Clippers

Double Personalized



#CP-35 \$28.00 ea.
(2-3 initials)

- Both R & L are on one double clip.
- Durable Stainless Steel clips.
- Color-coded: R side-Red / L side-Blue

Portable & Position Double Clippers



#CP-37
(port & position)
\$34.00 ea.



#CP-13
(position only)
\$34.00 ea.

Both are
available
with
initials.
Please
specify.

Standard Thin Clipper

- Constructed of high strength Kydex™.
- Extra thin profile, double-sided, 1 7/8" wide.
- R and L: 3/4", with or without initials.
- 2 Initials: 3/8"; 3 initials or words: 1/4".

#CPP-40
\$25.00 ea.



Side View

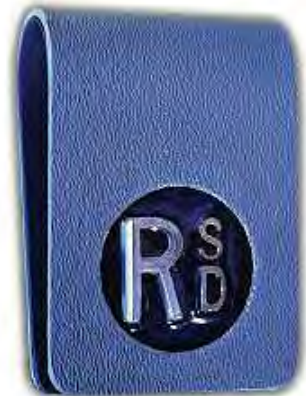

Gridcap Thin Clipper

- Designed to fit DR, CR receptors with gridcap.
- Constructed of high strength Kydex™.
- Extra thin profile, double-sided, 1 7/8" wide.
- R and L: 3/4", with or without initials.
- 2 Initials: 3/8"; 3 initials: 1/4".

#CPP-60 (with initials)
#CPP-61 (no initials)
\$35.00 ea.

**NEW for
Gridcaps**





ELITE Words (aluminum casing)

description	example	cat.# (3/8")	price	cat.# (1/2")	price
single letter	3	2E-Y	\$7.50	2E-Z	\$8.50
2-3 letters	EXT	3E-Y	\$10.00	3E-Z	\$12.50
4-5 letters	25 MIN	4E-Y	\$12.50	4E-Z	\$15.50
6-7 letters	STRESS	5E-Y	\$14.00	5E-Z	\$17.50
8+ letters	PORTABLE	6E-Y	\$16.00	6E-Z	\$20.00

*Personalized
Marker Sets
are on
pages 78-85*

IDENTIFIER Words (polystyrene casing)

description	example	cat.# (3/8")	price	cat.# (1/2")	price
single letter	3	2TA-Y	\$5.50	2TA-Z	\$6.50
2-3 letters	EXT	3TA-Y	\$9.50	3TA-Z	\$10.00
4-5 letters	25 MIN	4TA-Y	\$11.00	4TA-Z	\$11.50
6-7 letters	STRESS	5TA-Y	\$12.00	5TA-Z	\$14.00
8-15 / 8-10	PORTABLE	6TA-Y	\$15.00	6TA-Z	\$17.00



WAFER THIN Words

(1/4" letters x ^{3/32}"thin)

description	cat.#	price
single letter	WTW-01	\$14.00
2-3 letters	WTW-23	\$16.00
4-5 letters	WTW-45	\$18.00
6-7 letters	WTW-67	\$20.00
8+ letters	WTW-80	\$22.00



ONCOLOGY Words

(3/4" letters x 1/4" thick)

description	cat.# (3/4")	price
single letter	ROW-01	\$11.00
2-3 letters	ROW-23	\$14.00
4-5 letters	ROW-45	\$16.00
6-7 letters	ROW-67	\$19.00
8+ letters	ROW-80	\$22.00



Wall Boards

- Walnut grain w/brass hooks.

description	cat.#	price
32 Hook Board	HK-32	\$98.00
16 Hook Board	HK-16	\$78.00
8 Hook Board	HK-8	\$69.00

These are just a few suggestions from all possible word choices:

2-3 letters	4-5 letters	6-7 letters	8+ letters
AP	FLAT	AP ERECT	ANTERIOR
PA	FLEX	CLOSED	EXTENSION
ANT	INSP	INT ROT	INFUSION
EXP	LEFT	MOBILE	PORTABLE
EXT	OPEN	P EVAC	POST EVAC
INT	POST	POST OP	POST VOID
KUB	TOMO	RECUMB	STANDING
LAO	DECUB	STRESS	VERTICAL W/WEIGHT
LPO	ERECT	SUPINE	WEIGHT BEARING
MAG	HOURS	DELAYED	INJECTION
MIN	PRE OP	FLEXION	INVERSION
OBL	PRONE	LATERAL	SEMI ERECT
RAO	PUREE	MINUTES	VALSALVAR
LOA	RIGHT	OBLIQUE	WT BEARING
25	SCOUT	SUNRISE	COMPARISON
600	60 MIN	UPRIGHT	DECUBITUS

General Marker Set



Identifier Set shown (Board: 12" x 15")
3/8" letters / 1/2" numbers

Elite	Identifier
#GME-60	#GMI-65
\$540.00	\$490.00



#A-3 \$7.50 each
Arrow - 1" Elite Style



#TA-A3 \$5.70 each
Arrow - 1" Identifier Style

Cover Tab Stickers

- Ideal for coding mismarked or unmarked film.
- Color coded: L-Blue / R-Red.
- Self-adhesive backing.
- 1 1/4" diameter with square for initials.
- Available in greater quantity discounts!

cat.#	1-3 boxes	4-9 boxes	10+boxes
TAB-R	\$22.00	\$16.00	\$14.00
TAB-L	\$22.00	\$16.00	\$14.00



250
Stickers
per box

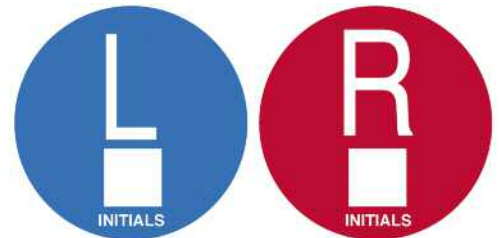

Take Advantage of
Quantity Discounts!



Example of the
MPA-19
Assorted Pack

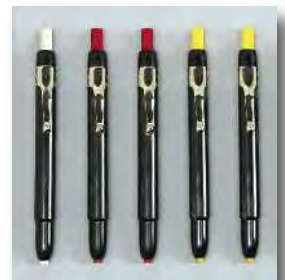

Marking Pens

- Highlights points of interest on a film.
- Wax markers resist smudging, but are not permanent.
- NOT to be used in place of lead markers.
- NOT a legally acceptable marking method.

Order each item per number of packs.

Example: 2ea. #MPY-11
(will be shipped with 10 yellow pens.)

PENS (5 per pack)

color	cat.#	price/pk
Yellow	MPY-11	\$30.00/pk
Red	MPR-12	\$30.00/pk
White	MPW-13	\$30.00/pk
2-Y, 2-R, 1-W	MPA-19	\$30.00/pk

REFILLS (72 per pack)

color	cat.#	price/pk
Yellow	MRY-21	\$20.00/pk
Red	MRR-22	\$20.00/pk
White	MRW-23	\$20.00/pk

Refills come in pkgs of 72 pieces.

Marker Keeper

- Convenient four-pouch vinyl holder for markers.
- Handy clip attaches the Marker Keeper to belt, lapel, pocket, etc.
- Keeps markers in easy reach for quick retrieval.



color	cat.#	price
Red	MKR-11	\$9.90
True Blue	MKB-12	\$9.90
Green	MKG-13	\$9.90
Yellow	MKY-14	\$9.90
Clear	MKC-15	\$9.90
*Assorted (4)	MKA-19	\$35.00

(*Assorted set does NOT include Clear.)



CHOOSE YOUR
OWN COLOR!

A tool pouch for your markers!

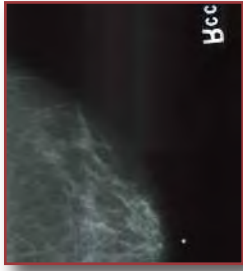

Skin Markers for General X-Ray, Mammography, MRI, CT and Oncology

GENERAL IMAGING: used to identify areas of pain or trauma, soft tissue masses, to document points of entry and exit sites, or mark prominent nipples for identification of nipple shadows on chest x-rays.

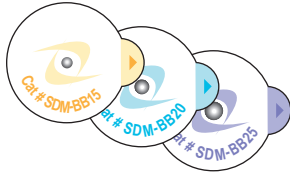
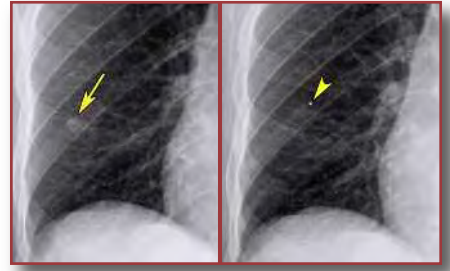

Skin Dots

cat.#	BB size		
SDM-BB15	1.5mm		
SDM-BB20	2.0mm		
SDM-BB25	2.5mm		
1-5 bxs	6-14 bxs	15+ bxs	
\$66.00	\$63.00	\$60.00	

(100 per box)

- Artifact/nipple identifier.
- Helps eliminate repeat exams.
- Lead-free.
- Easy-Peel tab.

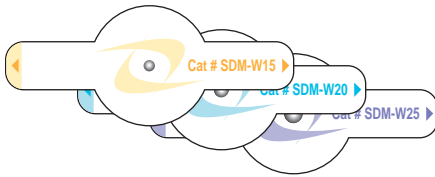

Skin Wings

cat.#	BB size		
SDM-W15	1.5mm		
SDM-W20	2.0mm		
SDM-W25	2.5mm		
1-5 bxs	6-14 bxs	15+ bxs	
\$69.00	\$66.00	\$63.00	

(100 per box)

- Artifact/nipple identifier.
- Extra support for larger, more prominent nipples.
- Lead-free.
- Easy-Peel tab.

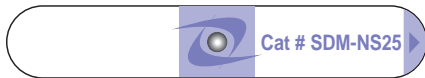

Skin Strip

cat.#	BB size		
SDM-NS25	2.5mm		
1-5 bxs	6-14 bxs	15+ bxs	
\$69.00	\$66.00	\$63.00	

(100 per box)

- Lead-free nipple identifier.
- Ideal for larger, more prominent nipples.
- Adhesive-free nipple zone.

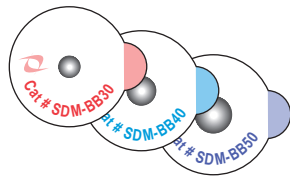

Skin Dots (Rad/Onc)

cat.#	BB size		
SDM-BB30	3.0mm		
SDM-BB40	4.0mm		
SDM-BB50	5.0mm		
1-5 bxs	6-14 bxs	15+ bxs	
\$123.00	\$118.00	\$113.00	

(50 per box)

- Lead-free artifact identifier.
- Larger BBs for Radiology and Oncology.
- Easy-Peel tab.

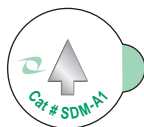

Skin Arrow (Rad/Onc)

cat.#	length		
SDM-A1	7.0mm		
1-5 bxs	6-14 bxs	15+ bxs	
\$103.00	\$99.00	\$95.00	

(100 per box)

- Lead-free arrow pointer.
- Highlights areas of interest for Radiology and Oncology.
- Easy-Peel tab.

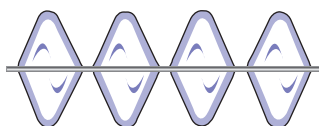

Skin Line

cat.#	line size		
SDW-S3	1.0mm		
1-5 bxs	6-14 bxs	15+ bxs	
\$83.00	\$79.00	\$75.00	

(120"/305cm per box)

- Lead-free scar identifier.
- Line contours to complex scar tissue.
- Flexible adhesive tabs; no scissors required.



Digital Mammography Skin Markers

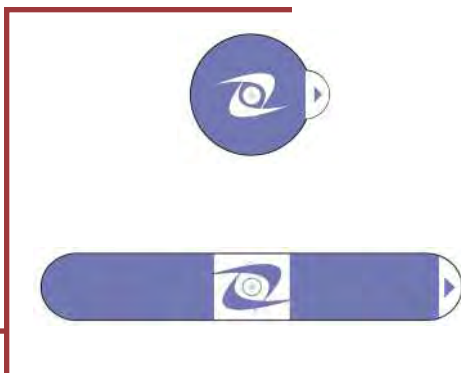

Digital Dot

cat.#	BB size	
SDM-BB23	2.3mm	
1-5 bxs	6-14 bxs	15+ bxs
\$66.00	\$63.00	\$60.00

(100 per box)

- Lead-free nipple identifier.
- Highlights areas of interest for digital and analog imaging.
- Easy-Peel tab.

Digital Strip

cat.#	BB size	
SDM-NS23	2.3mm	
1-5 bxs	6-14 bxs	15+ bxs
\$69.00	\$66.00	\$63.00

(100 per box)

- Lead-free nipple identifier.
- Ideal for larger, more prominent nipples.
- Adhesive-free nipple zone.

CT Skin Markers



CT Dot: 2.3mm

cat.#	BB size	
SDM-CT1	2.3mm	
1-5 bxs	6-14 bxs	15+ bxs
\$89.00	\$84.00	\$80.00

(50 per box)

- Lead-free 2.3mm marker.
- Highlights areas of interest for Radiology and CT.
- Easy-Peel tab.

CT Dot: 4.0mm

cat.#	BB size	
SDM-CT2	4.0mm	
1-5 bxs	6-14 bxs	15+ bxs
\$89.00	\$84.00	\$80.00

(50 per box)

- Lead-free 4.0mm marker.
- Highlights areas of interest for Radiology and CT.
- Easy-Peel tab.

Multi-Modality Skin Markers



Nuclear Med /PET

cat.#	hole size	
MM3003	5mm	
1-5 bxs	6-14 bxs	15+ bxs
\$239.00	\$234.00	\$229.00

(50 per box)

- 2mm center hole suitable for injection of radioisotope.
- Highlights areas of interest for Nuc. Med., PET, CT and MRI.

Therapy / Radiology

cat.#	hole size	
MM3005	5mm	
1-5 bxs	6-14 bxs	15+ bxs
\$199.00	\$194.00	\$189.00

(50 per box)

- 2mm center hole suitable for conventional hypodermic needle.
- Highlights areas of interest for Oncology and Radiology.

CT / MRI

cat.#	hole size	
MM3007	solid, no hole	
1-5 bxs	6-14 bxs	15+ bxs
\$214.00	\$209.00	\$204.00

(50 per box)

- No center hole; appears as bright object on CT and MRI scans.
- Also highlights areas of interest for radiology and mammography.

Economy Nipple-Artifact Markers

#LNA-20
\$50.00



- Encapsulated 2mm lead ball.
- Used to mark nipple, lesion, scar, artifact, etc.
- Neutral color, peel-off, self-adhesive backing.
- Non-sterile.
- 100 markers mounted on ten convenient strips. (This product contains lead.)

If you have any questions about the size characters you need or are looking for additional sizes and styles, please call our customer service department, or mail us a sample so that we may send you exactly what you're looking for.



UNmounted Lead Characters

style	(³ / ₁₆ ")	(¹ / ₄ ")	(³ / ₈ ")	(¹ / ₂ ")	(⁵ / ₈ ")	(1" R&L only)	(1" arrow)
FLAT FACE	XTUF-36 .49	XTUF-14 .49	XTUF-38 .49	XTUF-12 .59	XTUF-58 .59	XTUF-01 .99	X
DEEP BLOCK	X	XTUB-14 .89	XTUB-38 .99	XTUB-12 .99	(see Flat Face)	X	X
ARROWS	X	XTUA-14 .99	X	XTUA-12 .79	X	X	XTUA-01 .99

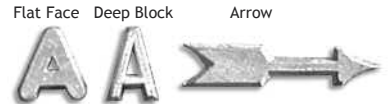

"Loose" lead letters & numbers.

Individual Mounted Characters (Flat Face)

cat.#	lead/plastic size	price	comments
XTSF-3658	³ / ₁₆ " on ⁵ / ₈ "	.79	Fits: LLH-58, LLH-2, LLH-3, Veri-Thin
XTSF-3634	³ / ₁₆ " on ³ / ₄ "	.79	Fits: Legal (regular)
XTSF-1458	¹ / ₄ " on ⁵ / ₈ "	.79	
XTSF-1434	¹ / ₄ " on ³ / ₄ "	.79	
XTSF-1478	¹ / ₄ " on ⁷ / ₈ "	.79	Fits: Eclipse, Perfection
XTSF-1234	¹ / ₂ " on ³ / ₄ "	.79	
XTIF-3658	³ / ₁₆ " on ⁵ / ₈ "	.79	Fits: Ideal (special offset mounting)



Characters are mounted on CLEAR flat plastic tabs to fit a variety of letter holders.

Flat Surface Mounted Words (Flat Face)

description	example	cat.#	price	cat.#	price	cat.#	price	cat.#	price
single letter	3	XVFW-0136	...79	XVFW-0114	...79	XVFW-0112	...89	XVFW-0101	1.29
2-3 letters	EXT	XVFW-2336	1.99	XVFW-2314	1.99	XVFW-2312	1.99	XVFW-2301	3.49
4-5 letters	25 MIN	XVFW-4536	3.49	XVFW-4514	3.49	XVFW-4512	3.69	XVFW-4501	5.99
6-7 letters	STRESS	XVFW-6736	4.99	XVFW-6714	4.99	XVFW-6712	5.29	XVFW-6701	8.79
8+ letters	PORTABLE	XVFW-8036	6.29	XVFW-8014	6.29	XVFW-8012	6.49	XVFW-8001	9.99
Lead/Plastic Sizes		³ / ₁₆ " on ³ / ₄ "		¹ / ₄ " on ³ / ₄ "		¹ / ₂ " on ³ / ₄ "		1" on 1 ¹ / ₂ "	



Words made from Mounted Letters glued to the surface of a single CLEAR vinyl strip.

Lead Letter Case

#XSLC-36 \$40.00

- Injection Molded Box.
- 36 scoop-bottom compartments (for A-Z and 0-9).
- Side compartment for holder.



Ideal Cushion Marker

#XSIC-21 \$50.00 ea.
Holder only. 3 1/2" x 1 5/16"

Double channel with cushions;
imprint in the upper section
of each channel.

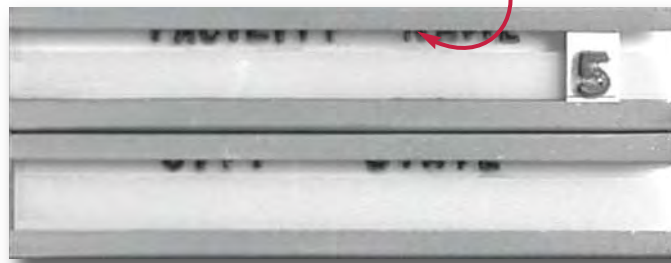

#XSIC-22 \$135.00 ea set
Complete Set Includes:
1ea. holder
2ea. A-Z
4ea. 0-9
2ea. A, E, I, O, U
1ea. 36-letter case

(Replacement characters:
3/16" on 5/8" plastic tabs, offset.
Reorder #XTIF-3658)

Eclipse Cushion Marker

#XSEC-11 \$45.00 ea.
Holder only. 3 1/2" x 1 5/16"

Single channel with cushion;
imprint above and below the
centerline.



#XSEC-12 \$90.00 ea set
Complete Set Includes:
1ea. holder
2ea. R, L
4ea. 0-9
1ea. 36-letter case

(Replacement characters:
1/4" on 7/8" plastic tabs.
Reorder #XTSF-1478)

Legal Marker

#XSLG-21 \$48.00 ea.
Holder only. 3 1/2" x 1 5/8"

Double aluminum channels:
imprint between the two
channels.



#XSLG-22 \$120.00 ea set
Complete Set Includes:
1ea. holder
2ea. A-Z
4ea. 0-9
2ea. A, E, I, O, U
1ea. 36-letter case

(Replacement characters:
3/16" on 3/4" plastic tabs;
Reorder #XTSF-3634)

Veri-Thin Legal

#XSVL-21 \$48.00 ea.
Holder only. 3 1/2" x 1 13/16"

Double aluminum channels;
imprint down and in between
the two channels.

Great for
Bucky Trays!



#XSVL-22 \$120.00 ea set
Complete Set Includes:
1ea. holder
2ea. A-Z
4ea. 0-9
2ea. A, E, I, O, U
1ea. 36-letter case

(Replacement characters:
3/16" on 5/8" plastic tabs.
Reorder #XTSF-3658)

Perfection

#XSPF-11 \$39.00 ea.
Holder only. 3 1/2" x 1 5/16"

Single aluminum channel;
imprint above and below
the channel.



#XSPF-12 \$90.00 ea set
Complete Set Includes:
1ea. holder
2ea. R, L
4ea. 0-9
1ea. 36-letter case

(Replacement characters:
1/4" on 7/8" plastic tabs.
Reorder #XTSF-1478)

Illuminated "In Use" Door Signs

- Lighted sign focuses attention on exam room status.
- Enhances Radiation Safety by suggesting the risk of accidental entry into an active exam room.
- NOT a plug-in sign; *must be hardwired* @ 120VAC.
- Each sign measures 11 1/2" x 2 1/2" x 7 1/4" h.
- Shipping weight of each sign: 4 lbs.

cat.#	description	price
SLU-XR	X-RAY IN USE	\$169.00
SLU-CT	CT IN USE	\$169.00
SLU-MR	MRI IN USE	\$169.00

Custom Signs

- Create your own illuminated sign for your specific needs.
- Artwork must fit 11 1/2" wide x 7 1/4" high.
- Shipping weight of each sign: 4 lbs.

cat.#	description	price
SLU-CX	Customer's Words	\$229.00



Safe-Spot Safelight

- Adjustable swivel & pivot base.
- Safe for high speed film.
- Filter is GBX-2 compatible
- Pull chain switch.
- 15-watt incandescent lamp.
- Shipping weight: 3 lbs.



safe-spot
#SSP-15 \$179.00

Replacement Filter (Dual Round)
#SFR-45 \$88.00/ea.
(Interior bulb can be replaced with 15-watt incandescent bulb.)



Fluoro-Safelight

- Ceiling or wall mount.
- 15-watt, 18" fluorescent lamp.
- Blue/Green film type filter will not dry or crack with age; GBX-2 compatible.
- Pull chain switch and 6 foot power cord.
- Shipping weight: 8 lbs.

fluorescent safelight
#SLS-15 \$225.00

Replacement Filter (Fluorescent)
#SFT-40 \$117.00/ea.
(White bulb can be replaced with any 15-watt cool white or warm white fluorescent tube.)



Film Duplicator (copier)

- Compact design uses less counter space; single UV lamp.
- FLAT GLASS contact surface - extremely easy to use.
- Non-rigid, floppy lid contours to film for excellent contact.
- Electronic timer with automatic reset.
- All metal housing.
- 18" w x 15" d x 12" h
- 110 VAC standard
- 1 year warranty (excl. glass & bulbs)
- Shipping weight: 31 lbs.

EASY! Place the original film and the copy film on the glass. Then, press "expose" and run through any standard processor.

#195D
\$725.00



Copy 14" x 17" Film with NO Moving Parts!



I.D. Cards - Standard

- Standard Cards measure 3" x 5".
- Each card is imprinted with standard legend.
- Each pack contains 1,000 cards.
- Shipped from stock.

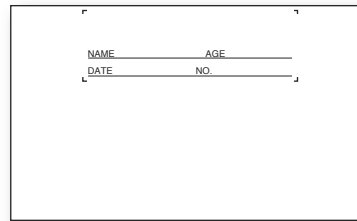

#IDS-02M \$46.00/pk
Blank with 2-Line Legend

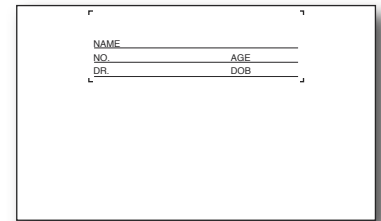

#IDS-03M \$46.00/pk
Blank with 3-Line Legend

I.D. Cards - Custom

- Custom Cards measure 3" x 5" with 1" x 3" imprint window (GE and Kodak compatible cards are 3¹/₄" x 7³/₁₆" with 1" x 2¹/₂" imprint window).
- Each card is imprinted with:
 - Your Custom Imprint (0, 1, 2 or 3 lines);
 - Custom Legend (0, 1, 2 or 3 lines);
 - (if not specified, standard legend will be used).
- Each pack contains 1,000 cards.

CUSTOM CARD BUILDER

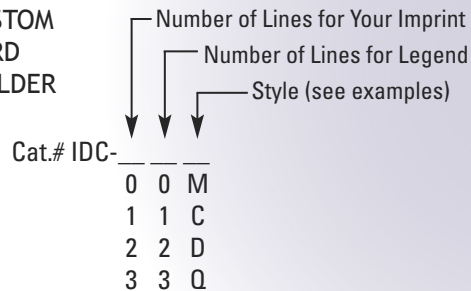

Artwork may not be an exact match to that of other suppliers.

Custom Cards are non-returnable.

If not specified, standard legend will be used.

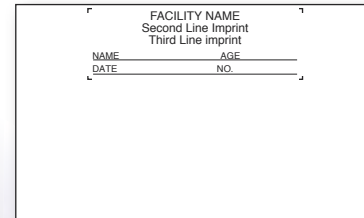

Example:
#IDC-32M

Most Popular Card!

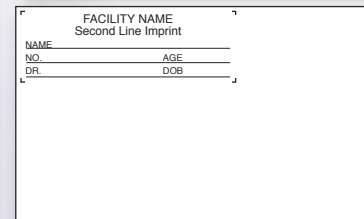

Example:
#IDC-23C

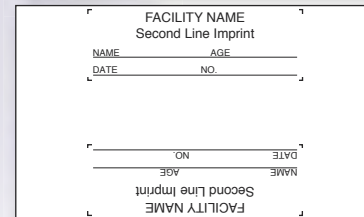

Example:
#IDC-22D

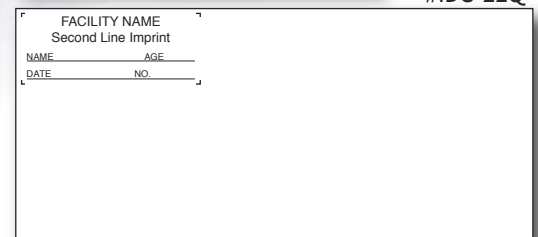

Example:
#IDC-22Q

style	imprint location	1000 cards	5000 cards*
M	Middle Top	\$55.00/M	\$49.00/M
C	Top Corner	\$55.00/M	\$49.00/M
D	Double Middle	\$63.00/M	\$57.00/M
Q	GE or Kodak (compatible)	\$65.00/M	\$59.00/M

(*5000 quantity is priced per 1000 cards.)

(When ordering, a faxed diagram is most helpful.)



I.D. Printer

#IDP-33
\$315.00

- Fully automatic exposure for perfect image prints.
- Adjustable exposure timer for most film types.
- Film positioning guides for middle or corner ID cards.
- Durable, all-metal housing.
- Plug-in model only; 110/120 VAC.
- 8" w x 8" d x 3" h.
- Shipping weight: 6 lbs.



- Illuminators or "view boxes" are the ideal light source for the proper diagnosis and interpretation of x-ray radiographs.
- Can be mounted virtually anywhere.
- Two styles: Standard and Techno•Vision.
- Provides the right conditions for efficient film reading.
- Three sizes cover most viewing needs.



single bank
#VBS-10 \$220.00
14" w x 3 1/2" d x 21 3/4" h
Shipping weight: 17 lbs.



double bank
#VBD-20 \$420.00
28" w x 3 1/2" d x 21 3/4" h
Shipping weight: 34 lbs.



Standard Illuminators (viewboxes)

- High quality, cost effective illuminators.
- Available in three models: 1, 2, and 4-bank.
- Upper and Lower Film Grips.
- Internal reflectors offer consistent illumination.
- Includes two 15-watt fluorescent lamps per viewing area.
- Use as stand alone or wall mounted.
- 6 foot power cord.
- UL listed.

single bank
With Film Activated Switch
#VVS-11 \$395.00
21" w x 1 9/16" d x 20 1/4" h
Shipping weight: 10 lbs.



Single Units accept VESA monitor mounts! (mounts not included)

Techno•Vision Illuminators (view surfaces)

Make the switch to high-tech lighting!

What's unique about Techno•Vision:

double bank
With Film Activated Switch
#VVD-21 \$725.00
35" w x 1 9/16" d x 20 1/4" h
Shipping weight: 16 lbs.



- Ultra-Slim design (only 1 9/16" thick!) gives a flush mounted look without the need for wall cut-outs.
- Over 90% light uniformity from edge to edge.
- Extra LONG LAMP LIFE at 50,000 hours!
- Single Bank units come with threaded holes to accept a standard 100mm VESA monitor mount (mount not included).
- Upper and Lower Film Grips.
- Film-Activated Switch available.
- EEFL lighting technology assures years of trouble-free service.
- Average light intensity is 5000 nits.
- 6 foot power cord.
- UL listed.

Mammography Illuminator

- Light source specifically designed to meet ACR Mammography Viewing requirements.
- Unit offers two (2) side-by-side film viewing areas for 24 x 30 film.
- Light intensity: 4,200 nits.
- Upper and Lower Film Grips.
- White powder coat finish.
- Includes four (4) 15-watt fluorescent lamps.
- UL listed with 5-foot power cord.
- Overall size: 20¹/₂"w x 3¹/₂"d x 16³/₄"h.
- Shipping weight: 17 lbs.



#VBM-24
\$530.00



Spinal Illuminator

- Light source designed for Orthopedic and Chiropractic film viewing.
- Unique viewing area for 14" x 36" film.
- Includes two 30-watt fluorescent lamps.
- Upper, Lower, and Mid-Height Film Grips.
- Stand alone or use the keyhole slots for wall mounting.
- White powder coat finish.
- UL listed.
- Overall size: 15"w x 3¹/₂"d x 39"h.
- Shipping weight: 25 lbs.



#VBO-36
\$480.00



View-Spot

- Aids in Dx by high-lighting specific areas of the film.
- Convenient desk stand.
- 75-watt incandescent bulb.
- 22,000 nits, light intensity.
- Remote, foot actuated switch.
- 6 foot power cord and UL listed.
- Shipping weight: 10 lbs.



#VSP-75
\$290.00



Standard X-Ray Film Jackets

- Choose one or two pockets.
- Non color-coded (see label selection for sticker styles and colors).
- Size: 14¹/₂" x 18¹/₄", including ³/₄" scored self expansion.
- Made of 11pt. manila stock.
- Black ink copy includes blocks for color-code labels and black loan indicator.
- Offset double thumbcut for easy access to contents.
- Double pocket version includes 10" x 15³/₄" report pocket with ³/₄" self expansion.
- Open side (opens along upper edge).



single pocket

cat.#	qty./ctn	wt./ctn	1-9 ctns	10-24 ctns	25+ ctns
JJL-SPS	100	22#	\$90.00	\$86.00	\$82.00



double pocket

cat.#	qty./ctn	wt./ctn	1-9 ctns	10-24 ctns	25+ ctns
JJL-DPS	100	25#	\$143.00	\$139.00	\$133.00

Multi-use Jackets



- Universal design allows many uses with one folder.
- Size: 9⁹/₁₆" x 12³/₄", including ³/₄" scored self expansion.
- Made of 11pt. manila stock.
- Universal copy includes check boxes for different exams.
- Offset double thumbcut for easy access to contents.
- Open side (opens along upper edge).

(May require long lead-time.)

cat.#	qty./ctn	wt./ctn	1-9 ctns	10-24 ctns	25+ ctns
JJM-SPU	200	19#	\$237.00	\$232.00	\$226.00

cat.#	description	qty./ctn	1-9 ctns	10-24 ctns	25+ ctns
see list	any single	1000/rl	\$23.00	\$21.00	\$19.00
JLL-CNS	0-9 set	10 rolls	\$230.00	\$210.00	\$190.00

cat.#	description	qty./ctn	1-9 ctns	10-24 ctns	25+ ctns
see list	any single	1000/rl	\$17.00	\$15.00	\$13.00
JLS-CCS	set of 10	10 rolls	\$170.00	\$150.00	\$130.00

large digit reverse block



(shown actual size: 1 7/8" x 1 7/8")

(shown actual size: 1 7/8" x 1 7/8")



large year

cat.#	year/color	qty./ctn	1-9 ctns	10-24 ctns	25+ ctns
JLL-Y13	13/orange	1000/rl	\$23.00	\$21.00	\$19.00
JLL-Y14	14/purple	1000/rl	\$23.00	\$21.00	\$19.00
JLL-Y15	15/black	1000/rl	\$23.00	\$21.00	\$19.00

Cat.#	Color	Cat.#
JLL-0RD	red	JLS-CRD
JLL-1GY	gray	JLS-CGY
JLL-2BL	blue	JLS-CBL
JLL-3OR	orange	JLS-COR
JLL-4PR	purple	JLS-CPR
JLL-5BK	black	JLS-CBK
JLL-6YL	yellow	JLS-CYL
JLL-7BN	brown	JLS-CBN
JLL-8PK	pink	JLS-CPK
JLL-9GN	green	JLS-CGN
JLL-CNS	(set of 10)	JLS-CCS
--	aqua	JLS-CAQ
--	gold	JLS-CGD
--	wallet	JLS-CNW
--	white	JLS-CWT

We stock the **AMES** Color System.
Other Color Systems available.

solid color bar label



(shown actual size: 1 3/4" x 1 1/2")

Color-Code Labels

- Features permanent adhesive and release coated paper backing.
- Superior flexibility for long life.
- Other color systems available.

(shown actual size: 1 3/4" x 1 1/2")

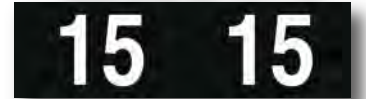

small year

cat.#	year/color	qty./ctn	1-9 ctns	10-24 ctns	25+ ctns
JLS-Y13	13/orange	1000/rl	\$14.00	\$12.00	\$10.00
JLS-Y14	14/purple	1000/rl	\$14.00	\$12.00	\$10.00
JLS-Y15	15/black	1000/rl	\$14.00	\$12.00	\$10.00

Mammography Jackets

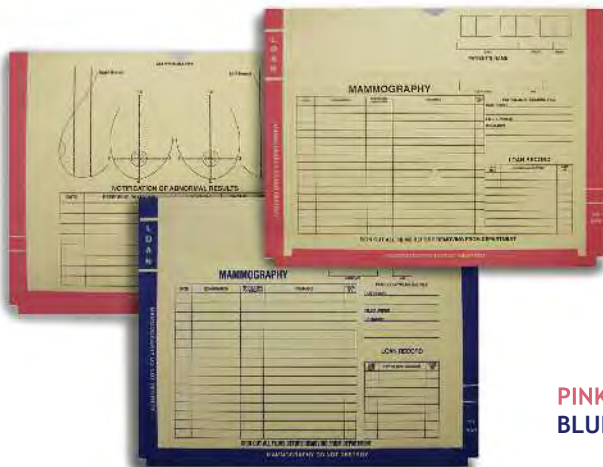

- Pink border identifies as separate from master jacket.
- Size: 11" x 14", including 3/4" scored self expansion.
- Pocket size: 8 1/4" x 11".
- Illustrated back allows for Dx & patient communication.
- Offset double thumbcut for easy access to contents.
- Open side (opens along upper edge).

cat.#	qty./ctn	wt./ctn	1-9 ctns	10-24 ctns	25+ ctns
JJM-PPM	200	30#	\$175.00	\$170.00	\$165.00
JJM-BBM	200	30#	\$175.00	\$170.00	\$165.00

PINK Border
BLUE Border

Category Inserts



- Locate specific examinations at a glance using solid-color and printed border stock color systems.
- Made of 32lb. white stock.
- Color coding by category permits quick location of films.
- "Open side" category name is printed on both sides of thumbcut; "open end" category name is printed on top and bottom of insert for easy identification.
- All inserts are available in open side (long edge) and open end (short edge) styles.
- Choose from two sizes:
 - large: 14 1/4" x 17 1/2"
 - medium: 10 1/2" x 12 1/2"

large size

size (inches)	qty./ctn	wt./ctn	1-9 ctns	10-19 ctns	20+ ctns
14.25 x 17.5	250	22#	\$97.00	\$92.00	\$87.00

open end#	open side#	category	stock	copy	border
JCL-ABE	JCL-ABS	Abdomen	White	Black	Lt. Green
JCL-ANE	JCL-ANS	Angio	White	Black	Purple
JCL-BEE	JCL-BES	BE*	White	Black	Gold
JCL-BNE	JCL-BNS	Bone	White	Black	Yellow
JCL-CHE	JCL-CHS	Chest*	White	Black	Brown
JCL-CTE	JCL-CTS	CT*	White	Black	Dk. Green
JCL-EXE	JCL-EXS	Extremities	White	Black	Yellow
JCL-GIE	JCL-GIS	GI*	White	Black	Gray
JCL-GUE	JCL-GUS	GU*	White	Black	Orange
JCL-HNE	JCL-HNS	Head & Neck	White	Black	Lt. Blue
JCL-IVE	JCL-IVS	IVP	White	Black	Salmon
JCL-MME	JCL-MMS	Mammography*	White	Black	Dk. Blue
JCL-MRE	JCL-MRS	MRI*	White	Black	Rust
JCL-NME	JCL-NMS	Nuclear Med	White	Black	Red
JCL-SEE	JCL-SES	Spine*	White	Black	Black
JCL-USE	JCL-USS	Ultrasound	White	Black	Purple

*Includes anatomical diagram on back.

size (inches)	qty./ctn	wt./ctn	1-9 ctns	10-19 ctns	20+ ctns
14.25 x 17.5	250	22#	\$155.00	\$150.00	\$145.00

open end#	open side#	category	stock	copy	border
JCL-NCE	JCL-NCS	(no category)	White	Black	Dk. Blue

medium size

size (inches)	qty./ctn	wt./ctn	1-9 ctns	10-19 ctns	20+ ctns
10.5 x 12.5	250	25#	\$97.00	\$92.00	\$87.00

open end#	open side#	category	stock	copy	border
JCM-BDE	JCM-BDS	Bone Density	White	Black	Yellow
JCM-MME	JCM-MMS	Mammography	White	Black	Dk. Blue
JCM-NME	JCM-NMS	Nuclear Med	White	Black	Red
JCM-USE	JCM-USS	Ultrasound	White	Black	Purple

Negative Preservers

- Available in three sizes to accommodate all films.
- All include stock copy lines for: file number, name, date, doctor and remarks.
- Made of 32lb. gold kraft stock.
- Thumbcut for easy access to films.
- Open end (opens along short side edge).
- Red and green available in large size, upon request.

cat.#	size	qty./ctn	wt./ctn	1-7 ctns	8-14 ctns	15+ ctns
JNS-OEK	8.5 x 10.5	500	25#	\$121.00	\$118.00	\$113.00
JNM-OEK	10.5 x 12.5	500	25#	\$150.00	\$145.00	\$140.00
JNL-OEK	14.5 x 17.5	250	22#	\$98.00	\$94.00	\$90.00

- With 1" Expansion Gusset

cat.#	size	qty./ctn	wt./ctn	1-7 ctns	8-14 ctns	15+ ctns
JNL-OEX	14.5 x 17.5	100	15#	\$244.00	\$236.00	\$228.00



CD/DVD Sleeves

- Standard 5" x 5" CD/DVD protection sleeves.
- Made of 60lb. white offset paper stock.
- Window made of clear polyester.

cat.#	qty./ctn	wt./ctn	1-7 ctns	8-14 ctns	15+ ctns
JCD-CSW	1000	14#	\$121.00	\$115.00	\$109.00



CD/DVD Mailers

- Features self-adhesive closure and tear-tape tab opening.
- Made of 20pt. coated white board.
- Economy; no liner.

cat.#	qty./ctn	wt./ctn	1-7 ctns	8-14 ctns	15+ ctns
JCD-CDX	200	15#	\$65.00	\$60.00	\$55.00



Cardboard Insert Mailers

- Available in two sizes.
- Made of 32lb. brown kraft stock.
- Open end, string & button closure.
- Chipboard insert for rigidity.
- Printed with bold black stock copy.

cat.#	size (inches)	qty./ctn	wt./ctn	1-9 ctns	10-19 ctns	20+ ctns
JMM-SBC	11 x 13	50	8#	\$59.00	\$56.00	\$53.00
JML-SBC	15 x 18	50	12#	\$69.00	\$65.00	\$61.00



Green Diamond Border Mailers

- Available in two sizes.
- Made of 11pt. manila stock.
- Open end, string & button closure.
- Green diamond border with red "X-Ray Film, please do not bend."

cat.#	Size (inches)	qty./ctn	wt./ctn	1-7 ctns	8-14 ctns	15+ ctns
JMM-SBD	11 x 13	50	7#	\$67.00	\$64.00	\$61.00
JML-SBD	15 x 18	50	10#	\$73.00	\$70.00	\$67.00



- Allows handling of files without damage to film or jacket.
- Heavy gauge vinyl welded together with heat-seal construction.
- Keeps records and film in one convenient location.
- Sealed chipboard insert for rigidity.



Standard Organizers

Color-Code
Files by Priority
or Department



- Ideal for transport / retrieval protection.
- 2-pocket design for files and jackets.
- Holds up to 14" x 17" film.
- Available in ten (10) colors.
- Cardboard insert for rigid construction.*
- Aids in increased file room efficiency.
- Overall size: 21" x 14 1/2".

cat.#	color	qty/ctn	1-4 ctns	5-9 ctns	10-19 ctns	20+ ctns
800	True Blue	20	\$136.00	\$129.00	\$124.00	\$116.00
810	Red	20	\$136.00	\$129.00	\$124.00	\$116.00
820	Yellow	20	\$136.00	\$129.00	\$124.00	\$116.00
830	Green	20	\$136.00	\$129.00	\$124.00	\$116.00
840	Purple	20	\$136.00	\$129.00	\$124.00	\$116.00
850*	Clear*	20	\$136.00	\$129.00	\$124.00	\$116.00
860	Teal	20	\$136.00	\$129.00	\$124.00	\$116.00
870	Maroon	20	\$136.00	\$129.00	\$124.00	\$116.00
880	Royal Blue	20	\$136.00	\$129.00	\$124.00	\$116.00
890	Orange	20	\$136.00	\$129.00	\$124.00	\$116.00

*(CLEAR caddies are flexible and do NOT have cardboard inserts.)

Techno-Tuff™ Maximum Duty Organizers



- Nylon mesh reinforced sides and bottom.
- Two mylar reinforced pockets.
- Cardboard insert for rigid construction.
- Rip and tear resistant.
- Available in five (5) colors.
- Overall size: 21" x 14 1/2".

THE
TUFF-EST
AVAILABLE!

cat.#	color	qty/ctn	1-4 ctns	5-9 ctns	10-19 ctns	20+ ctns
200	True Blue	10	\$147.00	\$126.00	\$105.00	\$95.00
210	Red	10	\$147.00	\$126.00	\$105.00	\$95.00
220	Yellow	10	\$147.00	\$126.00	\$105.00	\$95.00
230	Green	10	\$147.00	\$126.00	\$105.00	\$95.00
240	Purple	10	\$147.00	\$126.00	\$105.00	\$95.00

Records & Mammo Organizers



- Ideal for Medical Records, Mammo Film, CT, Ultrasound, Nuclear Medicine.
- 2-pocket design.
- Available in five (5) colors.
- Increases file room efficiency.
- Overall size: 13 1/2" x 10 3/4".

cat.#	color	qty/ctn	1-4 ctns	5-9 ctns	10-19 ctns	20+ ctns
400	True Blue	20	\$126.00	\$122.00	\$118.00	\$114.00
410	Red	20	\$126.00	\$122.00	\$118.00	\$114.00
420	Yellow	20	\$126.00	\$122.00	\$118.00	\$114.00
430	Green	20	\$126.00	\$122.00	\$118.00	\$114.00
440	Purple	20	\$126.00	\$122.00	\$118.00	\$114.00

Got Film? Get Tough!

Techno-Tuff™ X-Ray Filing Cabinets

The industry standard cabinets for *ARCHIVE* or *ACTIVE* film storage. Fully assembled, tough, and versatile.



#608A



#618A



#628A

- Pleasing, aesthetic design.
- All steel construction offers maximum strength.
- Solid back and side panels for security.
- 15³/₈" vertical shelf clearance.
- 12-gauge corner posts for vertical strength.
- Dividers are 6" apart.
- Full height dividers add vertical strength and stability.
- Full depth dividers prevent snagging and ripping of jackets.
- Available in eight (8) colors (see color chart).

cat.#	w x d x h (in.)	ships @	1-4	5-9	10-19	20+
608A	24x18x84	188#	\$589.00	\$583.00	\$577.00	\$567.00
618A	36x18x84	238#	\$699.00	\$689.00	\$679.00	\$659.00
628A	48x18x84	295#	\$932.00	\$923.00	\$904.00	\$885.00

SPECIAL NOTE ABOUT MOTOR FREIGHT:

Please provide information about your receiving area to determine standard or special delivery requirements.

Trucking companies will not unload shipments to accounts who do not have a commercial height receiving dock.

In most other circumstances, however, special arrangements can be made available at a reasonable extra freight charge.



Special Size Cabinets

- Same specs as the Standard Cabinets on page 28.
- STACKABLE (secures with nuts & bolts).
- Specify:
Base Unit (w/ dustplate)
or
Stacker (no plate).
(Base unit is 3" taller than a Stacker.)

- Only available on the 632XST.
- Flush-mounted paddle handles.
- Locks offer attractive security.
- Heavy duty construction.

**632XST
with locking
DOORS!**



#DR632XST 36" x 18" x 36"
\$795.00 Ships @ 170 lbs.



#631XST



#632XST



#633XST



#634XST

cat.#	tier	w x d x h (in.)	ships @	1-4	5-9	10-19	20+
631XST	1	36x18x20*	77#	\$222.00	\$215.00	\$213.00	\$208.00
632XST	2	36x18x36	115#	\$420.00	\$411.00	\$404.00	\$393.00
633XST	3	36x18x52	165#	\$549.00	\$536.00	\$524.00	\$514.00
634XST	4	36x18x68	212#	\$645.00	\$633.00	\$619.00	\$607.00

36" Wide Quantity Discounts

***IMPORTANT NOTE about Bases and Stackers:**

All units are shipped as Base Units which include a 3" dustplate, with the exception of the 631XST single-tier unit. This unit is shipped as a Stacker at 17" tall without a dustplate, unless a Base Unit at 20" tall is specified.

All Special Sizes ship:



Standard Paint | Custom Paint (non-returnable)



Almond (default)



Black



Putty



White



Twilight



Blue



Gray



Rose



**Think in Color,
Work in Color!**



Fully Assembled Records & Mammo Cabinet



MMU-4881 shown

- Designed for 10" x 12" mammo film and medical records.
- Seven shelves (six openings).
- 3 dividers per shelf on 36" unit, 4 dividers per shelf on 48" unit.
- All steel nut-bolt construction.
- Assembled and ready to use.
- Solid back and side panels.
- 11³/₄" vertical shelf clearance.



cat.#	w x d x h (in.)	ships @	price
MMU-3681	36x12x81	162#	\$605.00
MMU-4881	48x12x81	198#	\$735.00



Paint Color Chart is on p.102.

Stackable X-Ray File Cabinet



- Ideal for facilities with limited receiving area.
- No tools, no pins, and no hardware required.
- Each tier is individually boxed for easy unloading from UPS or motor carrier.
- Easy handling and set-up for facilities with minimal staff.

Locking door tier for x-ray cabinet



cat.#	description	price
SXC-13	X-Ray Top Cover	\$48.00
SXS-12	X-Ray Shelf (1-tier)	\$184.00
SXB-11	X-Ray Base	\$87.00
SXD-14	X-Ray Door (1-tier)	\$357.00



x-ray stackables (per tier)

- Holds folders for 14x17 film.
- Shelf: 32"w x 19"d x 16¹/₂"h., 38(70)lbs.
- Shelf vertical clearance: 15¹/₈".
- 2" tall Base: 7 lbs.



E-Z X-Ray Storage Boxes

- Allows for the efficient storage of x-ray film files. (Sold in case lots.)
- Strong and durable with reinforced handles.
- One piece, easy fold assembly.
- Can be stacked without crushing.
- Ideal for archiving files, temporary storage, or moving files.

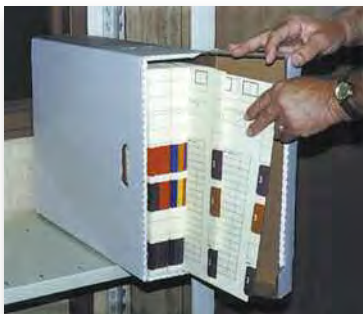

- Accommodates jackets up to 14" x 17".
- Upright: lid opens up. Side down: lid opens forward. (printed legend provided both ways.)
- Sized for OSHA lift load capacity.
- Each box O.D.: 6¹/₄" x 16" x 19¹/₂".
- Ships as 30 lbs. per case. 6 cases or less via FedEx/UPS. 7+ cases via motor freight.



Horizontal Filing



Vertical Filing

Cat.#ETX-70 (15 boxes per case)

# cases	price per case
1-3	\$129.00
4-7	\$124.00
8-15	\$119.00
16-49	\$114.00
50+	\$109.00

Protect your investment!

"CRC" CR-Plate Units have special, *impact resistant padding* on shelves and vertical surfaces to *prevent damage* to expensive CR-Plates.

Tall CR-Receptor Cart



Mini CR-Receptor Cart



All CRC Units ship:
MOTOR FREIGHT



Paint Color Chart is on p.102.

#CRC-38 \$795.00

- Eight 6" wide compartments @ 16 1/2" vertical clearance.
- Nominal size: 24" x 18" x 42 1/2"h.
- Shipping weight: 130 lbs.

#CRC-24 \$795.00

- Four 6" wide compartments @ 16 1/2" vert. clearance.
- Nominal size: 24" x 18" x 36"h.
- Shipping weight: 100 lbs.

Slim Line

Two-Tier

#SL-1
\$850.00

- 14-gauge welded steel.
- Two dividers per slanted shelf on 6 1/2" centers.
- Lower divided shelf has a 15 3/4" vertical clearance.
- 5" plate casters (2 locking).
- Nominal size: 20"w x 17"d x 49"h.
- Shipping weight: 141 lbs.



All Sideloaders ship:
MOTOR FREIGHT

Standard Utility Cart

#UC-70
\$275.00

- All-purpose utility cart. Ideal for sponges, linens, accessory items, etc.
- 150 pound capacity.
- Unassembled.
- 25" x 19" x 30"h.
- Shipping weight: 36 lbs.



Digital Support Cart

18" and 24" Wide Base with Laminate Top for CR readers, digitizers, viewers, monitors, keyboards, and other support or mobile equipment.



#DSC-1812BMK (25"x25" top)
\$1050.00
Includes the monitor/keyboard support for use with Afga CR-10X, Fuji Prima T & T2, and Konica Sigma. (Equipment shown not included.)

#DSC-2412AMK (30"x30" top)
\$1195.00
Includes the monitor/keyboard support for use with Afga CR30. (Equipment shown not included.)

DIGITAL EQUIPMENT CARTS

- Two sizes of carts (not including the tops):
 - 18"wide x 20"deep x 38¹/₄"tall,
 - 24"wide x 20"deep x 38¹/₄"tall.
- Three interior configurations:
 - open shelf over large shelf w/dividers,
 - large shelf w/dividers over open shelf,
 - three open shelves.
- Height of open shelf is 9".
- Height of shelf w/dividers is 20".
- Height of three open shelves: 9"/10"/9".
- Widths of 18" cart divided spaces are 3"/3"/12".
- Widths of 24" cart divided spaces are 6"/6"/12".
- Four sizes of laminate tops (choose the best for your application).
- All carts feature three cable holes in the back at each shelf level.
- Laminate top includes a hole for adding the DSM-MCP monitor mount.

TOP "A"
20"wide x 22"deep top on a 18"wide cart
Compatible suggestions:
- Vidar Sierra Plus
- Radlink LaserPro 16
- LogicRad
- AllPro Imaging SCAN12
- Protec ProScan35



#DSC-1812A
\$575.00

Also available in Neutral Tone Gray!

TOP "C"
25"wide x 25"deep top on a 24"wide cart
Compatible suggestions:
- Vidar Diagnostic ProAdvantage
- Kodak DryView 5800/5850
- Fuji DryPix 2000
- Konica/Minolta DryPro 832
- Codonics® Horizon



#DSC-2412C
\$695.00

TOP "B"
25"wide x 25"deep top on a 18"wide cart
Compatible suggestions:
- Vidar Diagnostic ProAdvantage
- Kodak DryView 5800/5850
- Fuji DryPix 2000
- Konica/Minolta DryPro 832
- Codonics® Horizon



#DSC-1812B
\$595.00

TOP "D"
30"wide x 30"deep top on a 24"wide cart
Compatible suggestions:
- Kodak DryView 5800/5850
- Array 2905
- AllPro ScanX 14
- Afga CR30 / Quantum CR30
- Kodak CR120/140/260/500
- Sony Filmstation



#DSC-2412D
\$745.00

Monitor & Combo Supports for 18" or 24" Carts

#ZEMS-SF21DM

(carts must be ordered separately)

#ZEMS-MC21DM



- Post mounts into a hole in the cart's top.
- Height adjusts with a locking lever.
- Includes standard VESA mount.
- Carts ordered separately.



TOP "E"
36"wide x 21"deep top on a 24"wide cart
Compatible suggestions:
- iCRCO 612SI/2000SL
- Afga DryStar 5300
- AllPro ScanX 14
- iCRCO ICR3600



#DSC-2412E
\$785.00

Equipment is shown for illustration and is not included.

Extension Monitor Arms

- Double-jointed horizontal movement
- Track-slide height adjustment

- Components can be easily relocated along support post.
- Includes: 1-31½" wall mount vertical track
1-extension arm keyboard tray
1-75mm/100mm VESA swivel mount
- Models with CPU Holder include an additional 31½" track (for 63" total) and CPU holder.

Single View Extension Arm Wall Mount

#ZEVW-ES21
\$700.00



Dual View Extension Arm Wall Mount

#ZEVW-ES22
\$850.00



Single View Extension Arm Wall Mount w/ CPU

#ZEVW-ET31
\$960.00



Dual View Extension Arm Wall Mount w/ CPU

#ZEVW-ET32
\$1120.00



Flip-Up Wall Mount

#ZEVW-SS21 \$490.00

- All components can be easily relocated along the vertical support post.
- Wall Mount System includes:
 - 1-31.5" wall mount vertical track
 - 1-FLIP-UP Keyboard tray
 - 1-75mm/100mm VESA swivel mount
 - All components slide independently

Flip-Up Wall Mount w/CPU

#ZEVW-TS31 \$830.00

- Same as above, but includes additional 31.5" track (for 63" total) and CPU holder.



Mobile Workstations w/ Extension Arms

Same as the Extension Wall Workstations on page 14, but with an all-steel mobile base.

- Mobile Workstation includes:
- 1-intergrated workstation
 - 1-steel post (total ht.: 67")
 - 1-stablizer H-base
 - 1-cable channel
 - 4-locking casters
 - 1-optional filler panel.

Single View Extension Arm Mobile Workstation

#ZTMW-ES21
\$1145.00



Dual View Extension Arm Mobile Workstation

#ZTMW-ES22
\$1270.00



Single View Extension Arm Mobile Workstation w/ CPU

#ZTMW-ET31
\$1355.00



Dual View Extension Arm Mobile Workstation w/ CPU

#ZTMW-ET32
\$1495.00



Mobile Workstation

#ZEMW-M250
\$680.00

- Self-contained cart for desktop PC or laptop.
- Platform height adjustment: 28" to 41".
- Five-star base with two locking casters.
- Weight capacity: 20 lbs.



#ZEMW-M500
\$1050.00
Same as ZEMW-250,
but also includes:

- Monitor support.
- CPU holder.



#ZEMW-M650
\$1140.00
Same as ZEMW-500,
but also includes:

- Keyboard tray.



Contour Front

Electric lift, height-adjustable desk. The contour front is designed to keep all of the desk surface within easy reach from any position. This desk is usually placed against a flat wall.

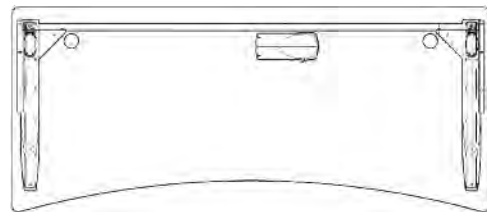
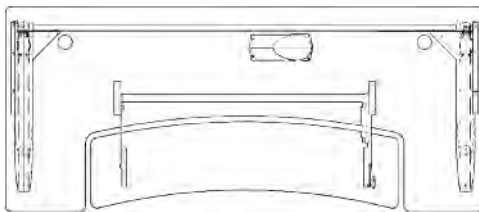
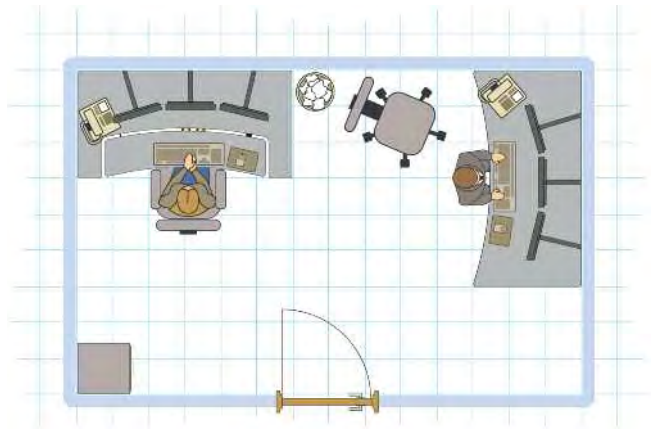

Divided Surface Lift (DSL)

cat.#	Length x Depth
ZLCD-E	60"- 96"* x 36" (lengths in 12" increments)

* (84" and 96" desks have a 60" wide DSL surface.)

Undivided Surface

cat.#	Length x Depth
ZLCU-E	60"- 96" x 36" (lengths in 12" increments)

WORK SURFACE:

- Laminated solid surface with high endurance PVC edging.
- Top is supported by a beamless frame that offers generous leg room.
- Models with the Divided Surface Lift (DSL) have 11³/₄" adjustment range: 6" above and 5³/₄" below the work surface with +9/-15° tilt.
- Custom sizes available; please call for quote.
- **Color choices are on page 111.**

ELECTRIC BASE:

- Includes 3-position programmable controller.
- 25" adjustment range: 25.5" - 50.5" (at 1.5"/sec).
- Load capacity: 300 lbs.
- Requires less than 3amps of power.
- Locking casters available.
- Limited Lifetime Warranty.



Straight Front

Electric lift, height-adjustable desk. The straight front is designed to resemble a standard desk and is usually placed against a flat wall.

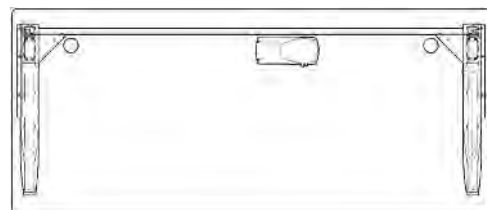
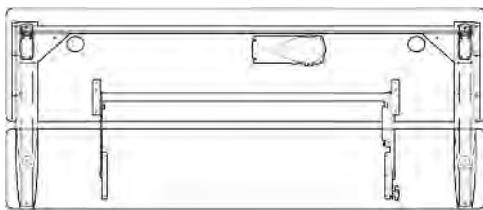
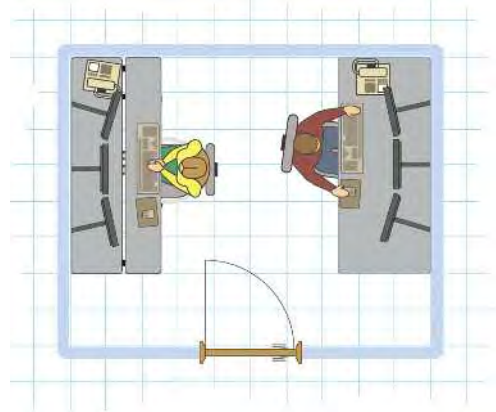

Divided Surface Lift (DSL)

cat.#	Length x Depth
ZLSD-E	48"- 96"* x 30" (lengths in 12" increments)

*(84" and 96" desks have a 72" wide DSL surface.)

Undivided Surface

cat.#	Length x Depth
ZLSU-E	48"- 96" x 30"-36" (in 12" increments)

WORK SURFACE:

- Laminated solid surface with high endurance PVC edging.
- Top is supported by a beamless frame that offers generous leg room.
- Models with the Divided Surface Lift (DSL) have 11³/₄" adjustment range: 6" above and 5³/₄" below the work surface with +9/-15° tilt.
- Custom sizes available; please call for quote.
- **Color choices are on page 111.**

ELECTRIC BASE:

- Includes 3-position programmable controller.
- 25" adjustment range: 25.5" - 50.5" (at 1.5"/sec).
- Load capacity: 300 lbs.
- Requires less than 3amps of power.
- Locking casters available.
- Limited Lifetime Warranty.



Corner View

Electric lift, height-adjustable desk. The corner view is designed to keep all of the desk surface within easy reach from any position. This desk is usually placed in a corner.

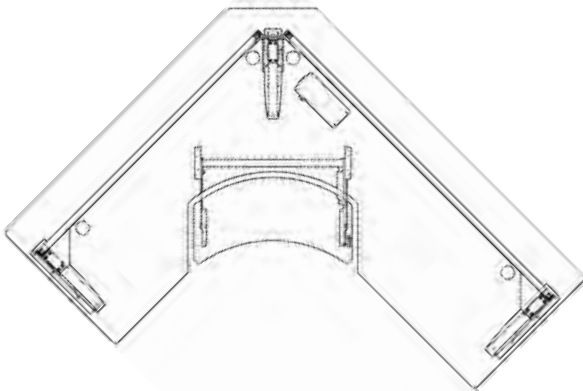
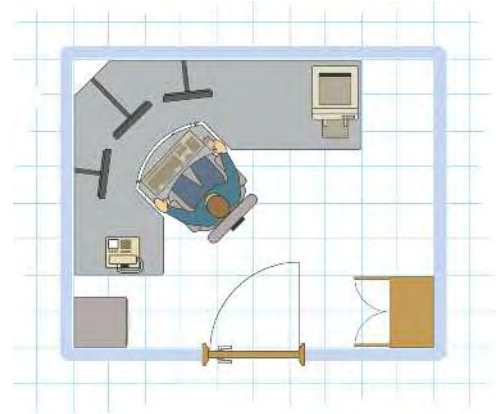

Divided Surface Lift (DSL)

cat.#	Left Wing x Right Wing
ZCVD-E	60"- 96" x 60"- 96" (30" wing depth) (wing lengths in 12" increments)

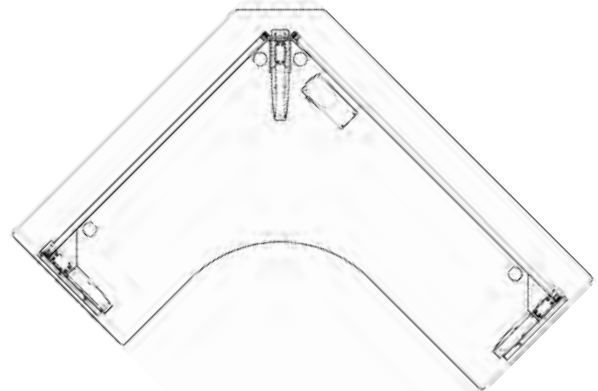

Undivided Surface

cat.#	Left Wing x Right Wing
ZCVU-E	60"- 96" x 60"- 96" (30" wing depth) (wing lengths in 12" increments)

WORK SURFACE:

- Laminated solid surface with high endurance PVC edging.
- Top is supported by a beamless frame that offers generous leg room.
- Models with the Divided Surface Lift (DSL) have 11³/₄" adjustment range: 6" above and 5³/₄" below the work surface with +9/-15° tilt.
- Custom sizes available; please call for quote.
- *Color choices are on page 111.*

ELECTRIC BASE:

- Includes 3-position programmable controller.
- 25" adjustment range: 25.5" - 50.5" (at 1.5"/sec).
- Load capacity: 300 lbs.
- Requires less than 3amps of power.
- Locking casters available.
- Limited Lifetime Warranty.





Sit-to-Stand Desks

Techno-Aide's FUSION-Ergo line of ergonomic furniture offers you comfortable and efficient solutions to meet your workspace needs.



Desktop Surface Laminate



Frame Support Color

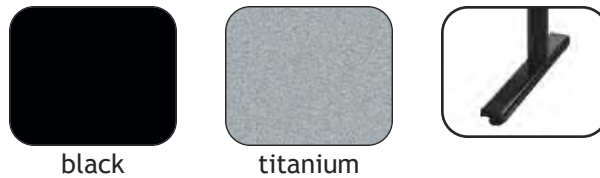

Default Colors:

- Desktop: black
- Frame: black
- Edging: black

(Custom laminates are available.)

Desktop Edge Band

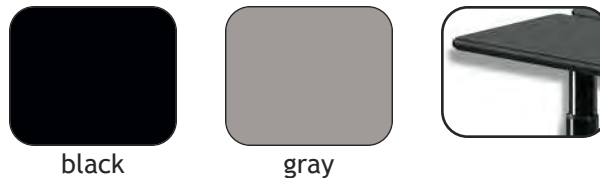

Example: #ZCVU-E7284

- Desktop: mahogany
- Base: black
- Trim: black

Locking Casters

#ZAC3-KE (includes 4 casters)
\$110.00/set of 4

- Set of four 3" locking casters.
- Changes desks into mobile platforms.
- Easy installation; can be retrofitted.
- *Not recommended for three-legged desks.*



Add 3" to your desk height!

Desktop Extending Monitor Supports

Single Monitor Extension Arm



#ZEMS-SF21
\$295.00

- Double-joint extension arm.
- 5"-24" extension range.
- 17" height range.
- Monitor weight capacity: 17½-lb. max.
- Pivot/tilt/rotate monitor.
- Clamp mount.

Dual Monitor Extension Arm



#ZEMS-SF22
\$395.00

- Double capacity of ZEMS-SF21 shown to the left.

Triple Monitor Extension Arm



#ZEMS-SF23
\$495.00

- Triple capacity of ZEMS-SF21 shown above.

Quad Monitor Extension Arm



#ZEMS-MF24
\$800.00

- Four times capacity of ZEMS-SA21 shown above.

Six Monitor Extension Arm



#ZEMS-MF26
\$970.00

- six times capacity of ZEMS-SF21 shown above.

Add-On Vertical Slide Adjuster

#ZEMS-AAMS
\$95.00

- Allows a monitor to be adjusted 5" above to 5" below the mount.
- Attached to standard monitor VESA bracket.



Single Monitor/Keyboard Combo



#ZEMS-MC21
\$480.00

- Double-joint extension arm.
- 5"-24" extension range.
- 17" height range.
- Monitor weight capacity: 20-lb. max.
- Pivot/tilt/rotate monitor.
- Includes gel palm rest.
- Clamp mount.

Dual Monitor/Keyboard Combo

#ZEMS-MC22
\$690.00

- Similar to the ZEMS-MC21 Single Monitor Combo shown to the left, but accommodates two monitors.



Equipment is shown for illustration and is not included.

Desktop Articulating Monitor Supports

Economy Articulating Arm



- Cat.# ZEMS-SV21
\$280.00
- Articulating gas spring directional adjustment.
 - 21" extension range.
 - 13" height range.
 - Monitor weight range: 6½-lb. min./17½-lb. max.
 - Pivot/tilt/rotate monitor.
 - Clamp mount.

Dual Economy Articulating Arms



- Cat.# ZEMS-SV22
\$480.00
- Similar to the ZEMS-SV21 to the left.
 - Supports two monitors on independent gas spring articulating arms.
 - Total COMBINED weight capacity is 35-lbs.

Single Articulating Arm Post Mount



- #ZEMS-PA21
\$330.00
- Articulating gas spring directional adjustment.
 - 21" extension range.
 - 12" height range.
 - 16" post increases range.
 - Easy height-adjust handle.
 - Monitor weight range: 6½-lb. min./17½-lb. max.
 - Pivot/tilt/rotate monitor.
 - Clamp mount.

Dual Articulating Arms Post Mount



- #ZEMS-PA22
\$580.00
- Similar to the ZEMS-PA21 to the left except:
 - Supports two monitors on independent gas spring articulating arms.
 - 28" post increases range.
 - Each arm holds: 6½-lb. min./17½-lb. max.

Wall Mount Monitor Supports

Wall Mount Monitor Support

#ZEMS-WA21
\$275.00

- Articulating gas spring directional adjustment.
- 21" extension range.
- 13" height range.
- Monitor weight range: 6.5-lb. min./17.6-lb. max.
- Pivot/tilt/rotate monitor.
- Wall mount.



Wall Mount for Small LCD Screens

#ZEMS-WA01
\$180.00

- Swivels at two points.
- Supports screens up to 36".
- Total reach: 11" outward.
- VESA 75mm and 100mm.
- Weight capacity: 33-lbs.



Retractable LCD Monitor Mount

#ZEMS-WAXR
\$450.00

- Supports 37" to 46" screens.
- Retracts to 8.7" and extends to 21.5".
- Swings 160° left or right.
- Screen pivots +/-15°.
- Weight capacity: 110 lbs.



Non-Retractable LCD Mount

#ZEMS-WFXP
\$240.00

- Supports 37" to 65" screens.
- Screen pivots +/-15°.
- Weight capacity: 176 lbs.



Universal CPU Support

#ZEDA-CPUU \$165.00

- Stores CPU underneath work surface.
- Features easy-access slide and swivel action.
- Adjustable width: 2 1/2" to 8 1/4".
- Adjustable height: 13" to 21".
- 100 lb weight capacity.

Mobile CPU Caddy

#ZEDA-CPUC \$89.00

- Stores CPU above the floor for easy access.
- Fits any CPU within a 3 1/2"-8 3/4" width.

Mini CPU Support

#ZEDA-CPUM \$130.00

- Space-saving mount for smaller CPUs.
- Fits CPU: 5"-20"h x 3 1/4"-6"w x any depth.
- 13 3/8" track and 360° swivel for easy access.
- 55 lb weight capacity.



Universal CPU Support



CPU Caddy

Mini CPU Support



MOST POPULAR

(CPUs not included)

Lift and Lock Keyboard Support

- Lift and Lock height adjustment.
- 7" height adjustment on 21" track: 2 1/2" above and 4 1/2" below the surface.
- 15° +/- tilt and 360-degree swivel.
- Mouse surface can be mounted on either side.
- Integrated gel palm rest.



#ZKKL-EX \$295.00

Keyboard Supports are not necessary on desks with the SSL. Keyboard not included.

Cable Management Channels

#ZACM-CC \$44.00/pair

- Pair of 24" "J" channels accommodate multiple cables and wires.
- Cables are quickly and conveniently stuffed into the channels for out-of-sight capture.
- Easily installs to the underside of desk with self-adhesive strips or screws (included).



Flexi-Lamp

#ZKDL-FFL \$170.00

- 20-watt halogen lamp.
- 25" gooseneck arm conveniently allows lamp to be adjusted into virtually any position for direct or ambient light.

Shines UP or DOWN for Ambient or Direct Light!



Flexi-Lamp

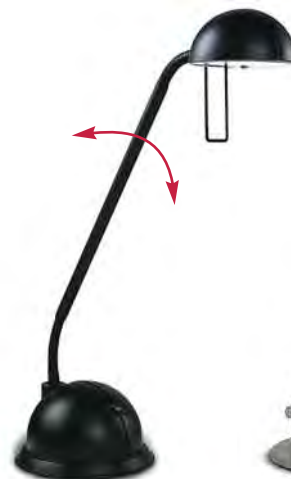

Hi-Lo Lamp



Fold-Away

Hi-Lo Lamp

#ZKDL-FHL \$155.00

- Three stage rocker switch (hi/low/off).
- 50-watt halogen lamp.
- Unique parabolic shade.
- Color correct lighting.

Fold-Away Lamp

#ZELD-FLDX \$295.00

- Dual arm articulating positioner.
- 6.5-watt LED with 4-step dimming.

Filing Drawer Pedestals

- Can be used under desks or as stand-alone units.
- Features easy-access glides on all drawers.
- Mini casters (two locking) provide easy movement.
- Steel construction for long life.
- Durable black powder coat finish.
- Size: 15" w x 23" d x 24" h*.
- Ships @ 35-lbs.

**NOTE: Depending on your desk, you may not be able to lower the desk to its lowest limit.*

Cat.# ZADF-20
\$250.00
(two file drawers)

Cat.# ZADF-30
\$275.00
(two utility drawers;
one file drawer)



Adjustable Footrest

#ZEDA-FR03 (platform rests 3" from floor.)
\$95.00

- Ideal for people who cannot rest feet on the floor or who want shift position.
- Sliding platform promotes ankle flexion, extension, and circulation.
- Durable, polished chrome metal frame.



Cupholder

#ZADA-CP
\$65.00

- Holds cups, mugs, and square bottles!
- Desk edge clamp mount.
- All-metal construction.



Pencil Drawer

#ZADU-PD
\$75.00

- Four small compartments and one large provide space for most everyday storage needs.
- 16" EZ-Slide ball bearing glides for smooth travel.
- Drawer dimensions: 20 1/2" w x 16 1/4" d 2" h.
- Opening requirements: 23" w x 16 1/4" d x 2" h.
- All mounting hardware is included.
- Surpasses ANSI/BIFMA standards.



Pencil Drawers may not fit on desks with the DSL.

Combo Copy/Telephone Support

#ZADA-CS
\$125.00

- Desk edge clamp mount.
- Gooseneck arm holds tray in any position.
- Adjust flat for lightweight phones.
- Hook & loop included for securing phone.
- Adjust upright for papers.
- Lower lip keeps booklets open.





OM5™
The Chair with INTUITION!

*Sit Up or Lean Back:
Intuitive Mechanism follows
your Body Movement and
Automatically Holds Position!*



- Self-weighting chair that intuitively responds to a wide range of body weights and sizes without the need for manual tension or tilt adjustments.
- Exclusive Poly Flex back slats with contouring mesh support.
- Mesh back: Zodiak Mesh offers breathability for comfortable sitting.
- seat height range: 16"-21" / seat: 19.75"w x 17"-18.5"d
- back: 18"w x 21"h / overall height: 37"-42"
- Limited Lifetime Warranty.
- Ships @ 101# (actual wt. 64#).

FABRICS
PAGE 120

OM5 with Arms

cat.#	choose fabric #	price
ZOM5-MA03	Grade 1-3	850.00
ZOM5-MA46	Grade 4-6	895.00
ZOM5-MALR	Black Leather	995.00

Discovery™

*Prevents Scapular Impedance
and Promotes Healthy Posture*



- EZ back height adjustment.
- Forward tilting, contoured and padded seat.
- Sliding and infinitely locking tilt seat.
- Infinitely adjustable tilt back.
- Seat height range: 18"-23"
- Seat: 20"w x 17"-19.5"d
- Health assisting back is 8"-16"w x 22"h.
- overall height: 40"-49"
- 12-year limited warranty.
- Ships @ 101# (actual wt. 59#).

300



With Arms

cat.#	choose fabric #	price
ZODC-FA03	Grade 1-3	860.00
ZODC-FA46	Grade 4-6	915.00

FABRICS
PAGE 120

No Arms

cat.#	choose fabric #	price
ZODC-FX03	Grade 1-3	710.00
ZODC-FX46	Grade 4-6	760.00

Relaxer Standard



Relaxer High-Back



Adjustable lumbar support lets you select your own comfort

- Adjustable lumbar support.
- Slide and tilt seat.
- Height-adjustable tilt back.
- Forward tilt and tension knob.
- Warranty: 12-year limited.
- Seat height range: 17"-22"
- Seat: 21" w x 18"-20.5" d



Standard only:

- back: 19.5" w x 22" h
- overall height: 37.5"-46.5"
- ships @ 101# (actual wt. 57#).

High-Back only:

- back: 19.5" w x 28" h
- overall height: 46"-55"
- ships @ 195# (actual wt. 63#)

FABRICS
PAGE 120

With Arms

cat.#	choose fabric #	price
ZORM-MA03	Grade 1-3	760.00
ZORM-MA46	Grade 4-6	825.00
ZORM-MALR	Black Leather	975.00

No Arms

cat.#	choose fabric #	price
ZORM-MX03	Grade 1-3	635.00
ZORM-MX46	Grade 4-6	695.00
ZORM-MXLR	Black Leather	850.00

With Arms

cat.#	choose fabric #	price
ZORH-HA03	Grade 1-3	815.00
ZORH-HA46	Grade 4-6	875.00
ZORH-HALR	Black Leather	1030.00

No Arms

cat.#	choose fabric #	price
ZORH-HX03	Grade 1-3	685.00
ZORH-HX46	Grade 4-6	750.00
ZORH-HXLR	Black Leather	905.00

Flair

Provides cushioned support across the back and shoulders



- Created for everyday work environments.
- Independent adjustability on backrest and seat angles.
- EZ back height adjustment.
- Tilting backrest.
- Sliding seat.
- Seat tilting.
- Seat height range: 16.5"-21.5"
- Seat: 20.5" w x 18"-20.5" d
- Back: 20" w x 21" h.
- overall height: 38"-46"
- 12-year limited warranty.
- Ships @ 101# (actual wt. 52#).

FABRICS
PAGE 120

With Arms

cat.#	choose fabric #	price
ZOFL-MA03	Grade 1-3	570.00
ZOFL-MA46	Grade 4-6	620.00
ZOFL-MALR	Black Leather	750.00

No Arms

cat.#	choose fabric #	price
ZOFL-MX03	Grade 1-3	460.00
ZOFL-MX46	Grade 4-6	505.00
ZOFL-MXLR	Black Leather	640.00

**YEStm
Standard**



With Arms

cat.#	choose fabric #	price
ZOYS-MA03	Grade 1-3	595.00
ZOYS-MA46	Grade 4-6	630.00
ZOYS-MALR	Black Leather	710.00

No Arms

cat.#	choose fabric #	price
ZOYS-MX03	Grade 1-3	495.00
ZOYS-MX46	Grade 4-6	520.00
ZOYS-MXLR	Black Leather	595.00

- The Perfect blend of support, comfort, and style.
- Features contoured lumbar area and mesh-back comfort.
- EZ back height adjustment.
- Three-stage locking tilt.
- Synchronous seat/back tilt.
- Seat slider.
- Warranty: 12-year limited.
- Seat height range: 17.5"-22.5"
- Seat: 20.5"w x 18"-20"d

Standard only:

- back: 19"w x 20"h
- overall height: 35.5"-43.5"
- ships @ 101# (actual wt. 52#).

High-Back only:

- back: 20"w x 24"h with headrest.
- overall height: 46"-55"
- ships @ 101# (actual wt. 63#)

FABRICS
PAGE 120

Comfort Seating is ideal for desks, workstations, and everyday tasks.

**YEStm
High-Back**



With Arms

cat.#	choose fabric #	price
ZOYS-HA03	Grade 1-3	740.00
ZOYS-HA46	Grade 4-6	770.00
ZOYS-HALR	Black Leather	850.00

No Arms

cat.#	choose fabric #	price
ZOYS-HX03	Grade 1-3	630.00
ZOYS-HX46	Grade 4-6	660.00
ZOYS-HXLR	Black Leather	740.00

Maxi



- Full size, strength, & support.
- Weight rated at 400-lbs.
- Rocking tilt.
- EZ back height adjustment.
- Tilting backrest.
- Sliding seat.
- Seat tilting.
- Seat height: 18" 
- Seat: 24"w x 17"-19.5"d
- Back: 23.5"w x 25"h.
- overall height: 43"-52"
- 7-year limited warranty.
- Ships @ 195# (actual wt. 68#).

With Arms

cat.#	choose fabric #	price
ZOMX-MA03	Grade 1-3	1060.00
ZOMX-MA46	Grade 4-6	1125.00

No Arms

cat.#	choose fabric #	price
ZOMX-MX03	Grade 1-3	950.00
ZOMX-MX46	Grade 4-6	995.00

FABRICS
PAGE 120

Accent

- Sturdy side/guest chair.
- Silver powder-coat frame.
- Seat: 18"w x 18"d
- Seat height: 18"
- Back: 19"w x 16"h.
- Overall: 21"w x 32"h.
- 7-year limited warranty.



cat.#	choose fabric #	price
ZOAS-SX03	Grade 1-3	195.00
ZOAS-SX46	Grade 4-6	235.00
ZOAS-SBP	Black Plastic	119.00

Elemental Standard



- Comfortably meets all multi-task and office requirements.
- Back height adjustment.
- Tilting backrest.
- Pivot backrest.
- Tilting seat.
- Warranty: 7-year limited.
- Seat: 19" w x 19" d.
- Back: 19" w x 17.5" h.

Standard only:

- seat height range: 16"-21"
- overall height: 35"-43"
- ships @ 101# (actual wt. 52#).

Stool only:

- seat height range: 23"-33"
- overall height: 42"-55"
- 20" chrome footring.
- ships @ 68# (actual wt. 46#)

FABRICS
PAGE 120

With Arms

cat.#	choose fabric #	price
ZOEC-MA03	Grade 1-3	385.00
ZOEC-MA46	Grade 4-6	435.00

No Arms

cat.#	choose fabric #	price
ZOEC-MX03	Grade 1-3	330.00
ZOEC-MX46	Grade 4-6	375.00

Elemental Stool



With Arms

cat.#	choose fabric #	price
ZOES-MA03	Grade 1-3	430.00
ZOES-MA46	Grade 4-6	475.00

No Arms

cat.#	choose fabric #	price
ZOES-MX03	Grade 1-3	375.00
ZOES-MX46	Grade 4-6	420.00

Task Seating and Stools are ideal complements for standing desks.

Universal Stool

#ZBCH-USB (Black ONLY)
\$299.00



- Self-skinned urethane seat and back.
- Height adjustable footring.
- Seat height: 22"-32"
- Overall ht: 37"-47"
- 7-year limited warranty.
- Ships @ 37#.











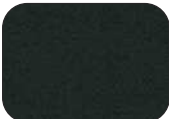



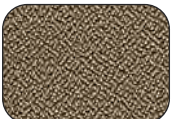

Hover Sit-to-Stand

#ZOWS-15 (Black ONLY)
\$260.00

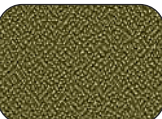

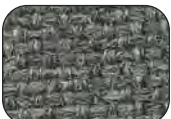
- Sit-while-standing helps ease lower back stress.
- Seat tilts forward 20°.
- Seat height: 22"-32"
- Overall ht: 28.5" w x 38.5" h.
- 7-year limited warranty.
- Ships @ 33#.

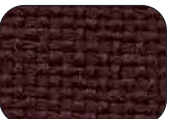









Grade 1 Fabric (Elements)	 1140-Carbon	 1141-Titanium	 1143-Boron	 1144-Oxygen	 1147-Iodine	 1148-Chlorine
Grade 1 Fabric (Spice)	 1161-Pepper	 1163-Nutmeg	 1166-Sesame	 1164-Juniper	 1167-Paprika	 1168-Mint
Grade 1 Fabric (Basic)	 1020-Black	 1001--Charcoal	 1004-Navy	 1005-Blue	 1013-Burgundy	 1002-Gray

Grade 2 Fabric (Casino)	 2258-Wynn	 2253-Paris	 2259-Caesar	 2254-Stardust	 2257-Rio	 2256-Mirage
Grade 2 Fabric (Chess)	 2291-King	 2292-Knight	 2293-Castle	 2294-Bishop	 2297-Queen	 2298-Pawn
Grade 2 Fabric (Moonscape)	 2260-Eclipse	 2261-Moonrock	 2263-Rover	 2264-Apollo	 2267-Crescent	 2268-Earthshine

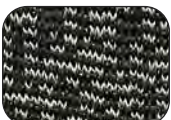
Grade 3 Fabric (Sahara)	 3311-Lava	 3313-Dunes	 3316-Sunrise	 3314-Nile	 3317-Canyon	 3318-Cactus
-------------------------------	--	---	---	---	--	--

Grade 4 Vinyl (Stage)	 V50-Cats	 V53-Grease	 V55-Aida	 V52-Chicago	 V59-Fame	 V58-Shrek
Grade 4 Vinyl (Symphony)	 V20-Piano	 V21-Drum	 V26-Trumpet	 V25-Flute	 V27-Cello	 V28-Harp

Grade 5 Fabric (Comfort Knits)	 5501-Flint	 5503-Smoke	 5506-Cappucino	 5515-Baltic	 5539-Wine	 5512-Xanadu
Grade 5 Fabric (Matrix)	 5541-Morpheus	 5540-Trinity	 5546-Tank	 5544-Neo	 5547-Zion	 5549-Link

Terms & Conditions

Terms

- Net 30 days for approved accounts.
- New accounts may be opened on a Prepaid basis pending credit approval.
- Freight Charges are prepaid and added to the invoice.
- Invoiced shipping, handling, and insurance charges are \$6.95 or greater, depending on actual freight costs.
- FOB Destination: Freight Prepaid and Added from Nashville, TN, USA, or other authorized location.
- In Tennessee, Sales Tax is billed unless a valid exemption certificate is on file with Techno-Aide at the time an order is placed (Required by Federal Law).
- International Customers: All terms and policies are governed by specific Pro Forma Invoice.
- For your convenience, we accept MasterCard, VISA, American Express and Discover for prepaid orders.

- PRICING: We reserve the right to change prices or discontinue products without notice, but only as a last resort.

- SPECIAL NOTE: Motor freight companies will not unload shipments to accounts who do not have a suitable commercial height receiving dock, nor will they unload large or heavy items to ground level. Many times, however, advanced arrangements for curbside unloading can be made by facility personnel or the shipment can be made to your location for dealer delivery. For an additional charge and notification at the time of order, "Inside Delivery" or Cartage can be requested. The specifics of this service, however, are governed by your local freight terminal.

Return Policy

- Products cannot be returned to Techno-Aide, for credit or otherwise, unless accompanied by a Return Authorization Number issued by the Customer Service Department.
- All authorized returns are subject to a minimum 20% refurbishing and reconsignment fee.
- All protective apparel returns are subject to a minimum 50% breakdown and restocking fee.
- All returns must be shipped in the original packaging.
- No returns 45 days past the invoice date will be allowed.
- Techno-Aide will authorize returns for complete credit in the case of Techno-Aide error or defective merchandise.
- A Credit Memo will be issued only after the returned merchandise has been received and inspected by Techno-Aide.
- No returns will be allowed for personalized, custom items or Designer Colors unless they are defective.
- Damages on returned items are the responsibility of the shipper. For proper credit to be considered, every effort should be made to assure a damage-free return.

Damaged Goods Policy

- The carrier has signed for receipt of merchandise from our factory and has accepted them in good condition.
- If your shipment arrives damaged or incomplete, it is the consignee's (ship-to) responsibility to note visible damage or shortages on the Bill of Lading BEFORE the carrier leaves. FAILURE TO NOTE ANY DISCREPANCIES ON THE BILL OF LADING WILL VOID ANY ATTEMPTED FREIGHT CLAIM and/or DELAY OR FORFEIT ANY CUSTOMER CREDIT.
- Techno-Aide will be glad to assist you by having an inspector from the carrier come to inspect the shipment and by working with you for any necessary replacements. Replacements are treated as separate orders, requiring their own purchase order number for billing. Any possible credits will be issued on the original order.
- Whether the damage is visible or concealed, KEEP ALL PACKAGING MATERIALS FOR THE CARRIER INSPECTOR.
- Reporting and inspection must be made within seven (7) days after delivery. Delayed reporting can delay or void the carrier's responsibility to pay your claim and negate any credit for freight damage from Techno-Aide.

www.techno-aide.com
www.fusionergo.com